

CONGRATULATIONS on CHOOSING CUSTOM WOOD MOLDING

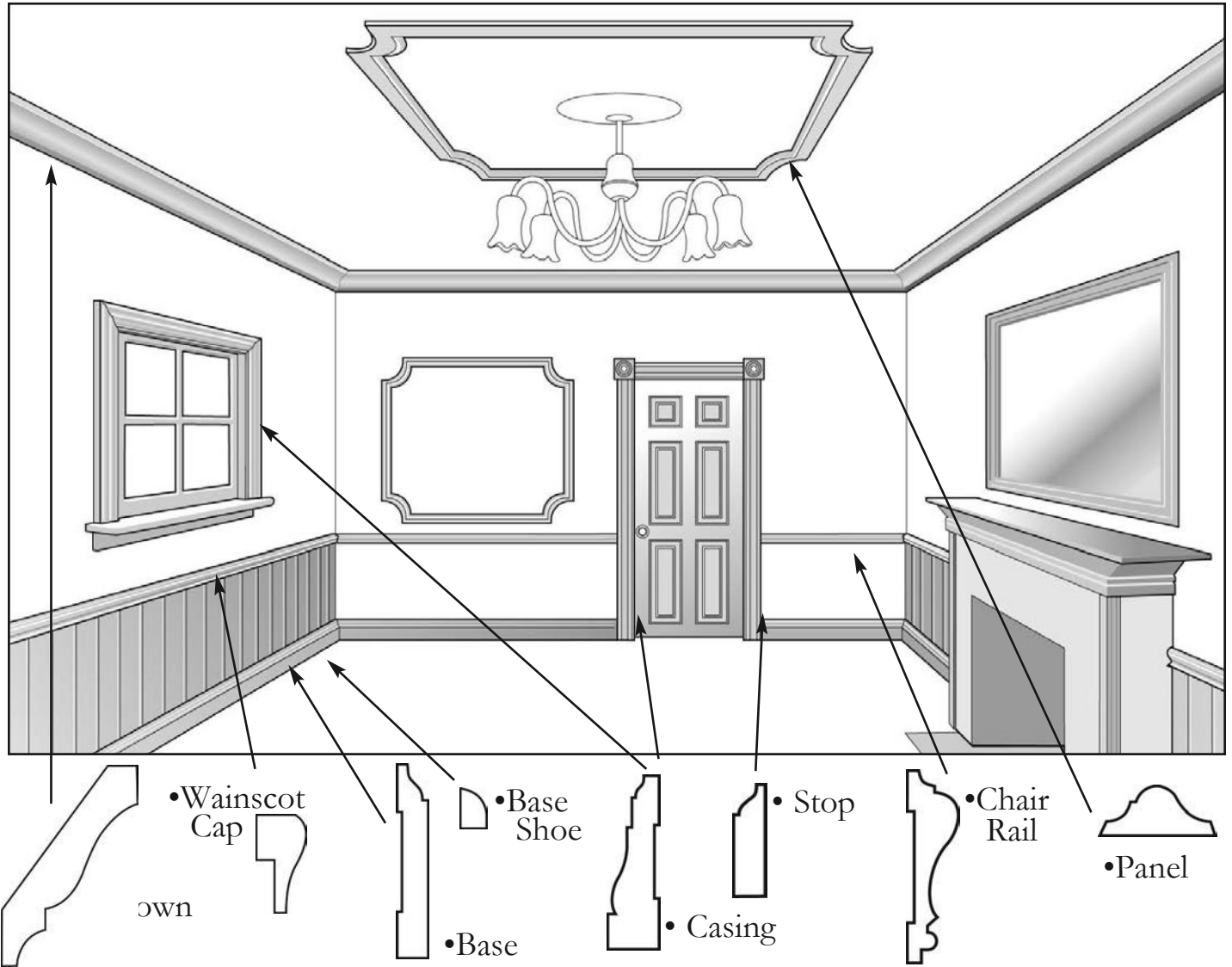

Adding WOOD MOLDING to a room is like putting a frame around a picture: the perfect finishing touch that enhances both beauty and value.

The woodworker you are consulting with can make any of the more than 600 molding patterns shown in this book as well as CUSTOM molding patterns, too.

PICTURE FRAME - Molding Patterns

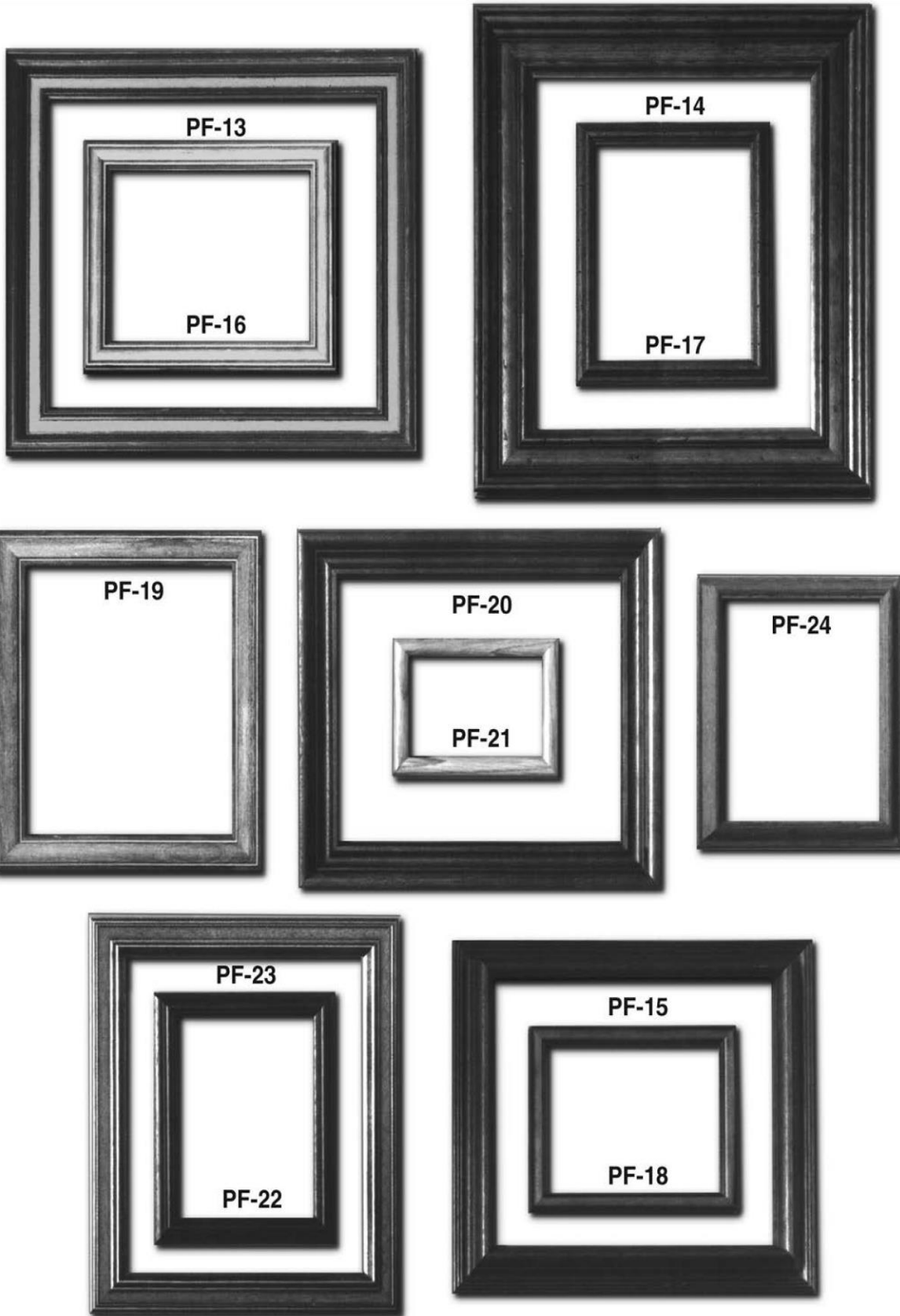

Molding Patterns - PICTURE FRAME

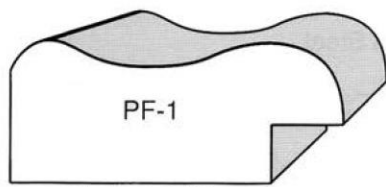

$3/4" \times 1-3/4"$

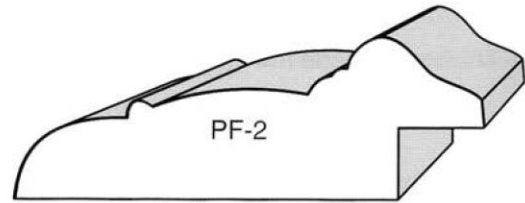

$7/8" \times 2-7/16"$

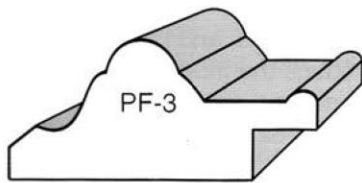

$3/4" \times 1-5/8"$

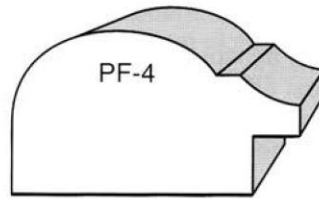

$1-3/16" \times 1-1/2"$

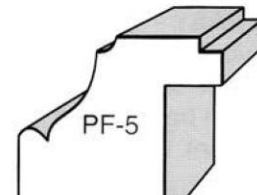

$1" \times 1-1/16"$

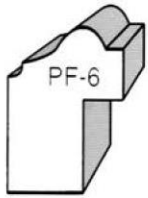

$7/8" \times 5/8"$

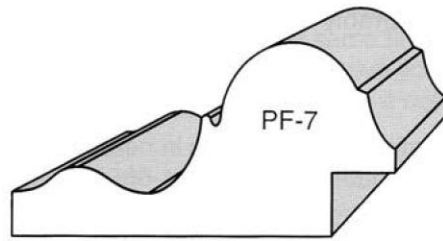

$1" \times 2"$

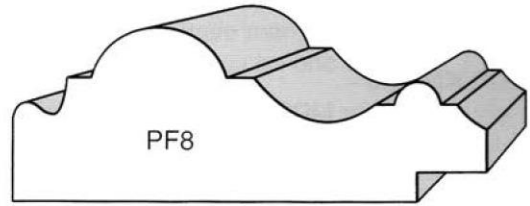

$15/16" \times 2-9/16"$

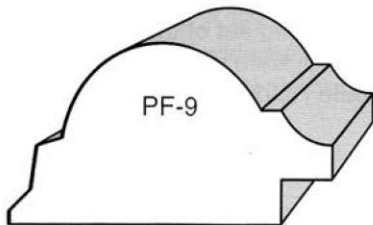

$15/16" \times 1-11/16"$

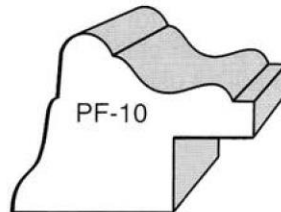

$15/16" \times 1-1/4"$

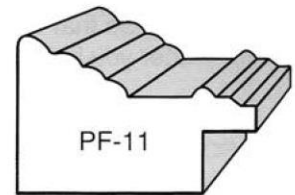

$13/16" \times 1-1/4"$

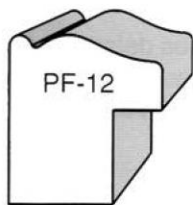

$7/8" \times 13/16"$

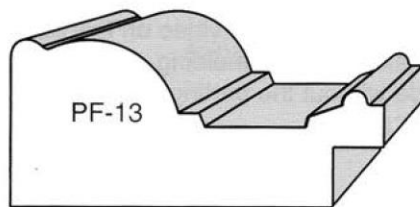

$7/8" \times 1-15/16"$

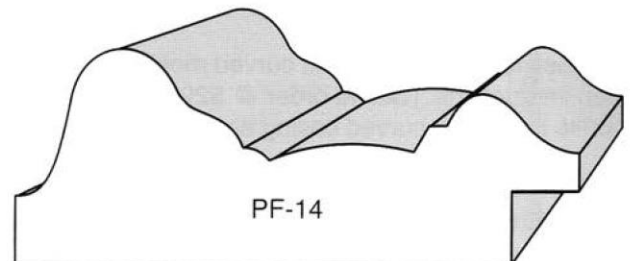

$1-1/8" \times 2-15/16"$

PICTURE FRAME - Molding Patterns

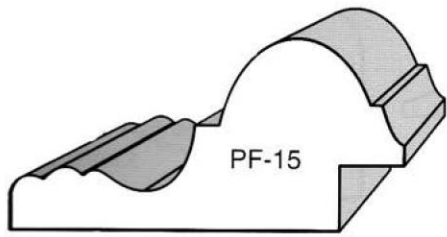

1 x 2-1/16"

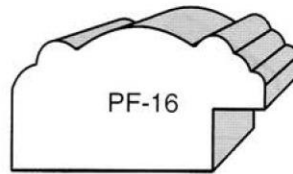

3/4" x 1-5/16"

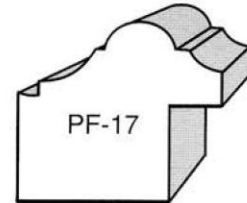

15/16" x 1-1/16"

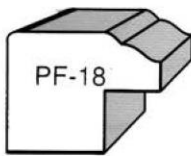

5/8" x 13/16"

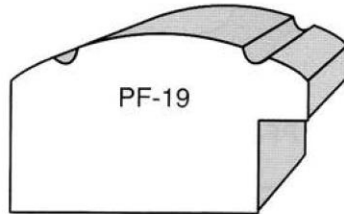

15/16" x 1-9/16"

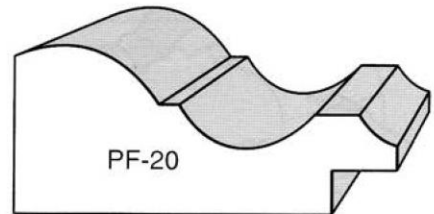

7/8" x 2"

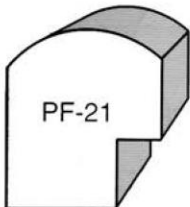

15/16" x 13/16"

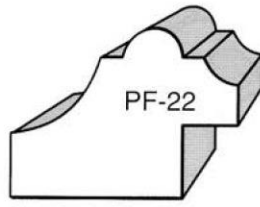

7/8" x 13/16"

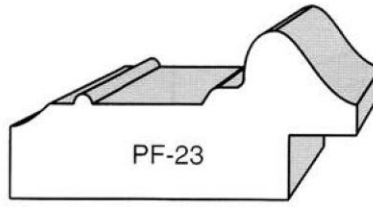

7/8" x 1-13/16"

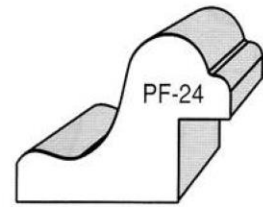

7/8" x 1-1/8"

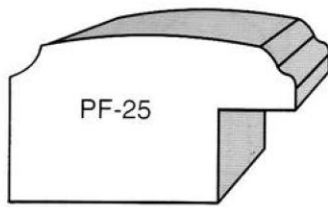

7/8" x 1-1/2"

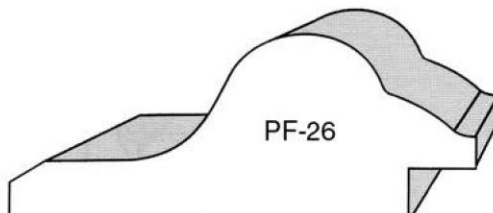

1" x 2-7/16"

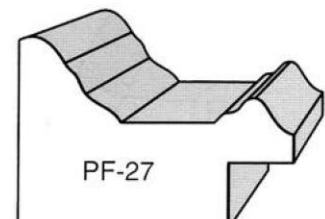

1" x 1-7/16"

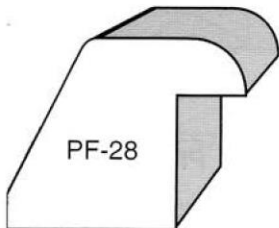

1" x 1-1/4"

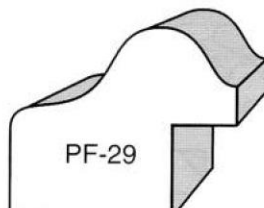

1" x 13/16"

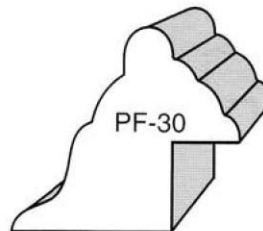

1-1/16" x 1-1/16"

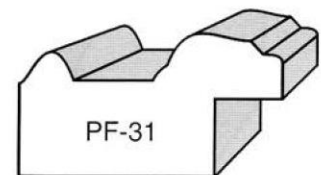

3/4" x 1-3/8"

Molding Patterns - PICTURE FRAME

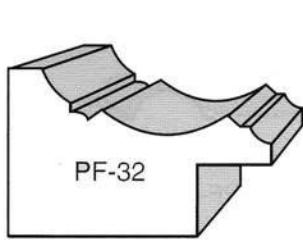

7/8" x 1-3/8"

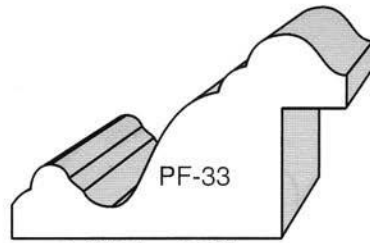

1-1/16" x 1-3/4"

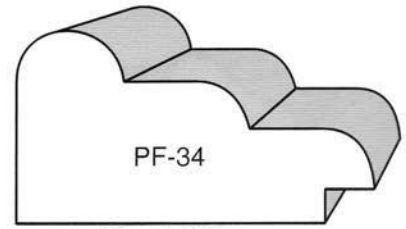

1" x 1-7/8"

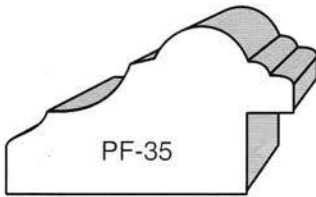

7/8" x 1-1/2"

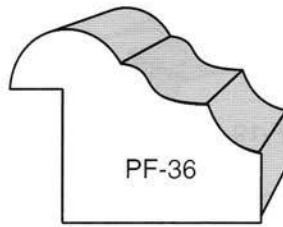

1" x 1-5/16"

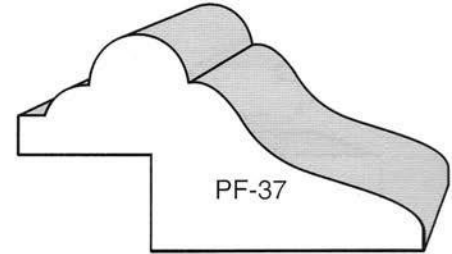

1-1/8" x 2-1/8"

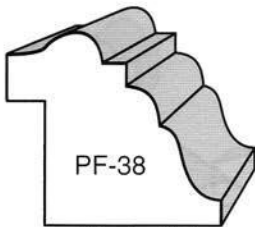

1" x 1-1/8"

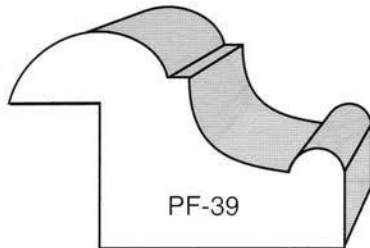

1-1/8" x 1-3/4"

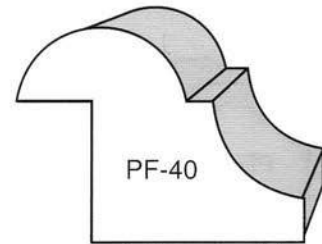

1-1/8" x 1-1/2"

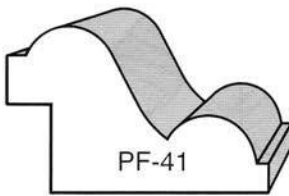

7/8" x 1-3/8"

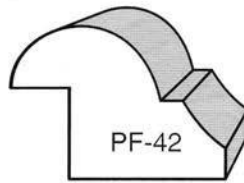

13/16" x 1-1/8"

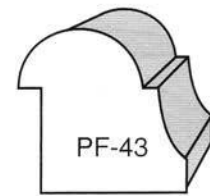

7/8" x 7/8"

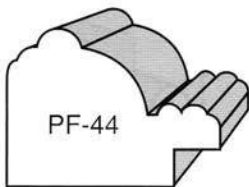

7/8" x 1-1/8"

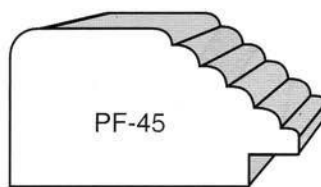

7/8" x 1-1/2"

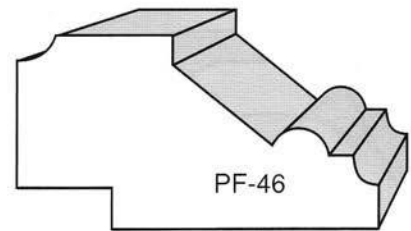

1" x 1-7/8"

PICTURE FRAME - Molding Patterns

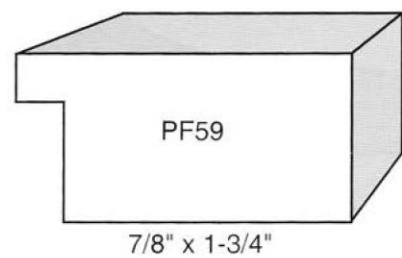
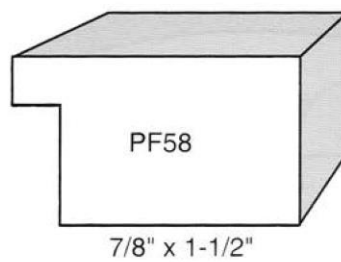
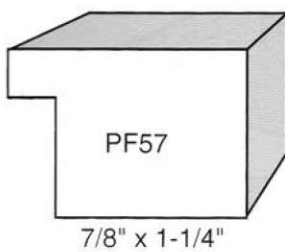
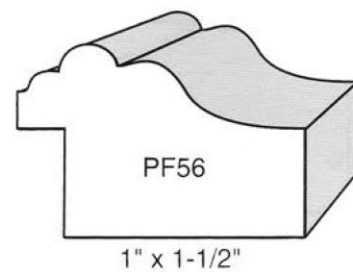
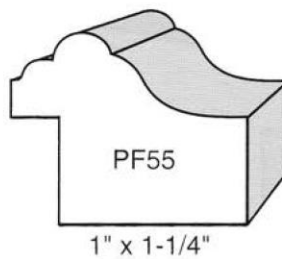
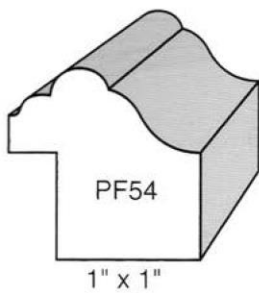
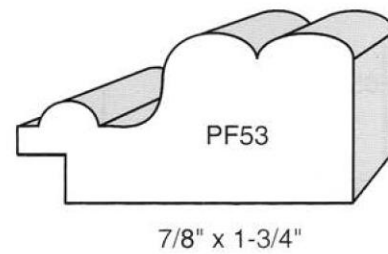
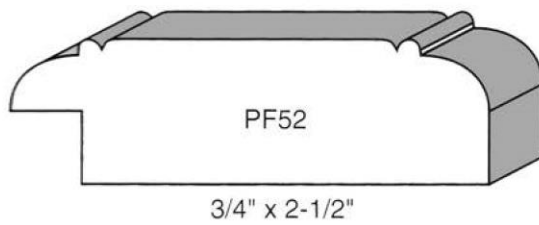
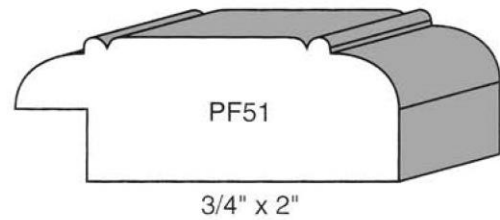
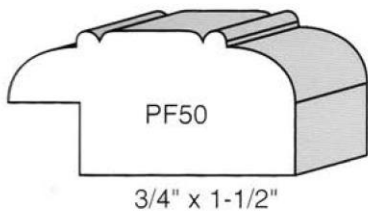
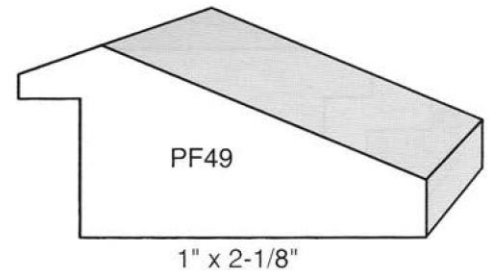
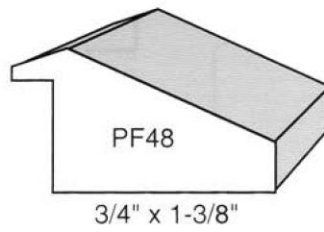
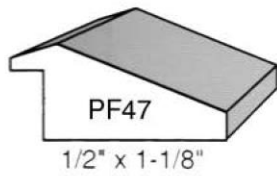

Molding Patterns - PICTURE FRAME

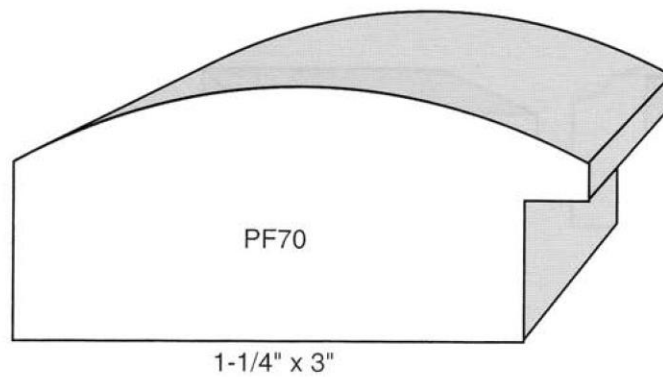
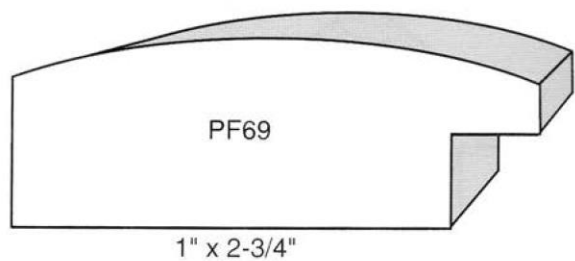
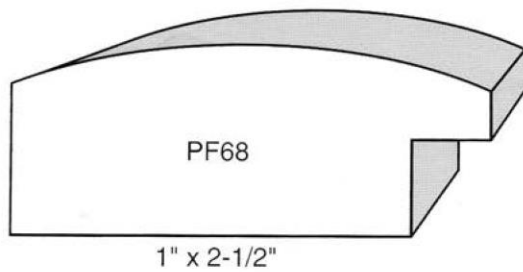
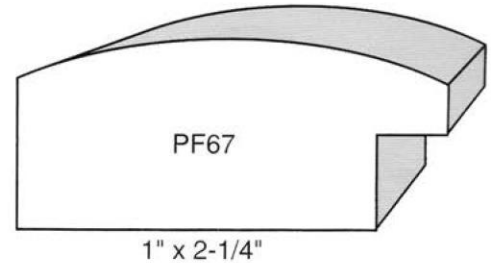
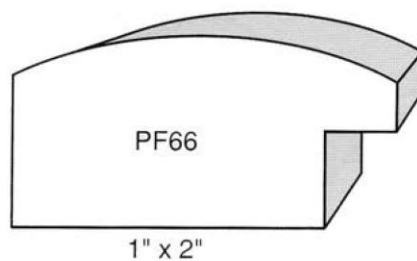
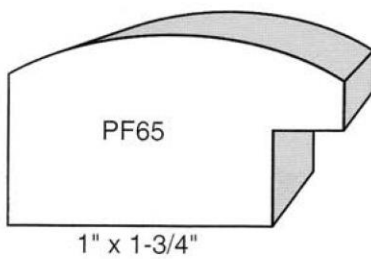
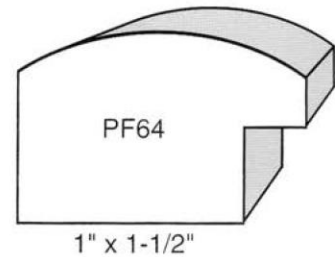
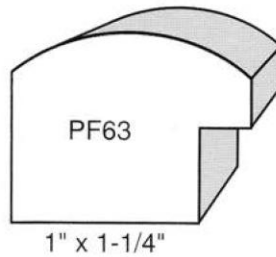
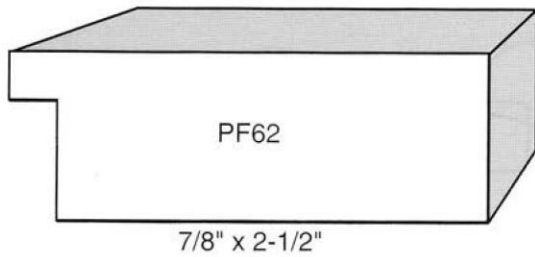
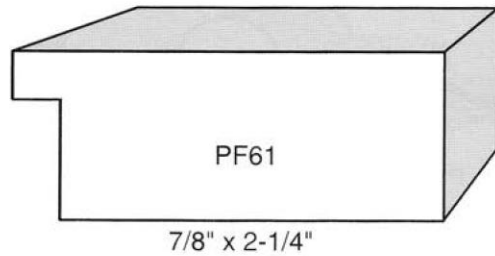
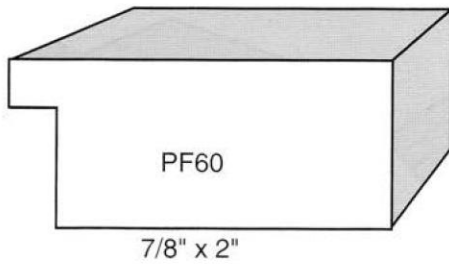

PICTURE FRAME - Molding Patterns

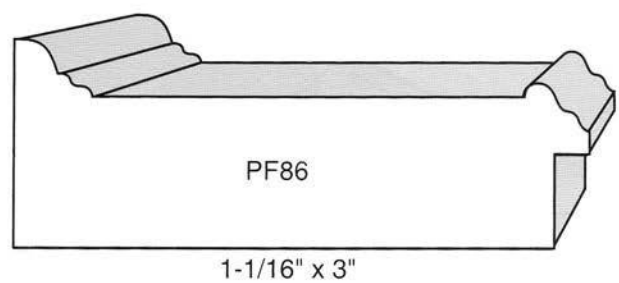
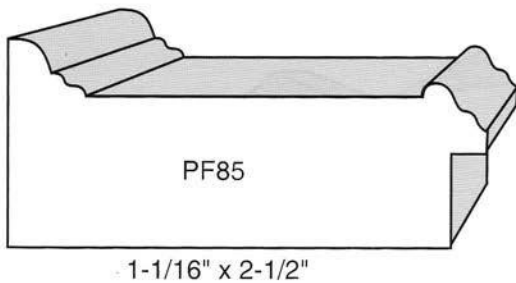
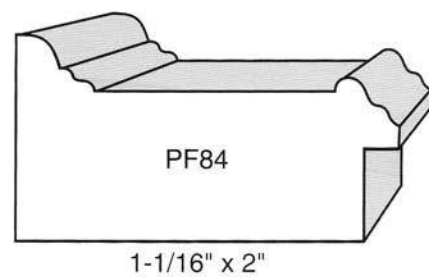
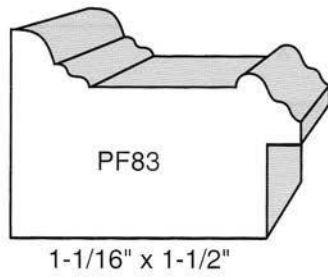
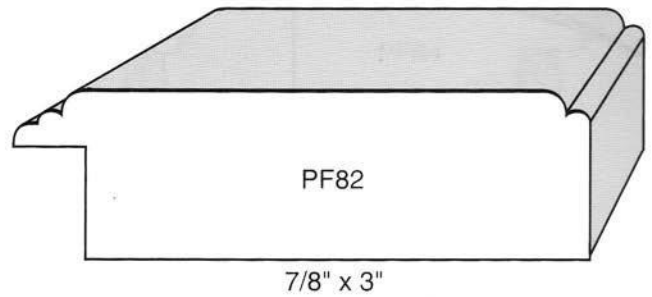
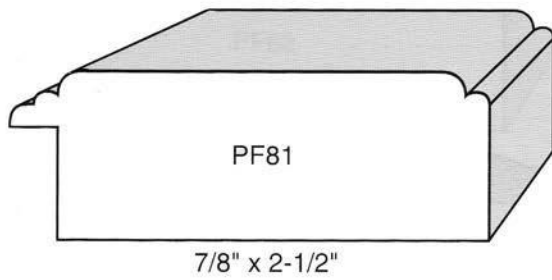
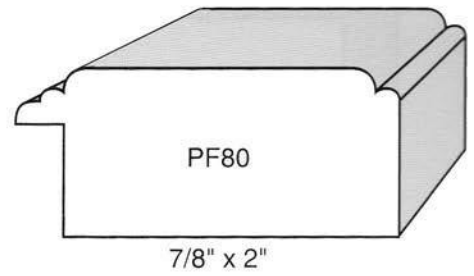
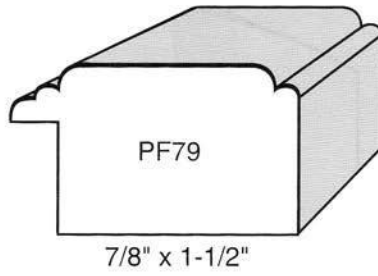
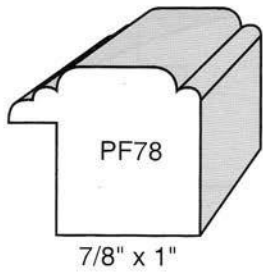

Molding Patterns - PICTURE FRAME

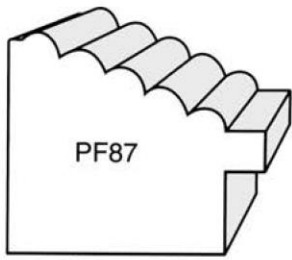

1-1/8" x 1-3/8"

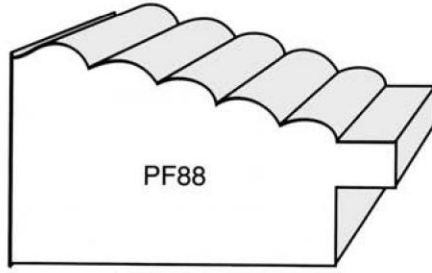

1-3/16" x 2"

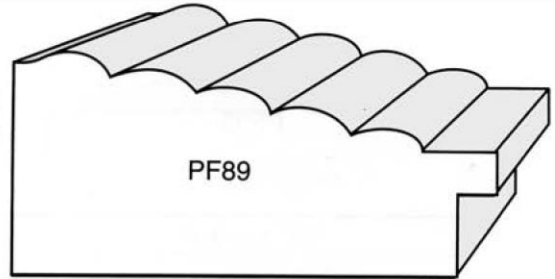

1-3/16" X 2-1/2"

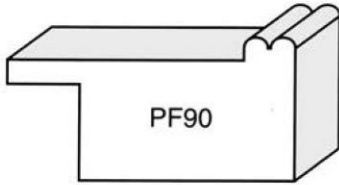

3/4" x 1-1/2"

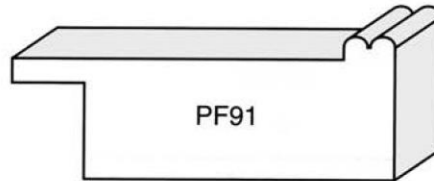

3/4" x 2"

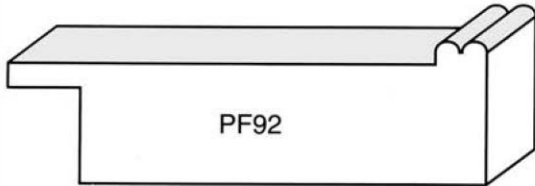

3/4" x 2-1/2"

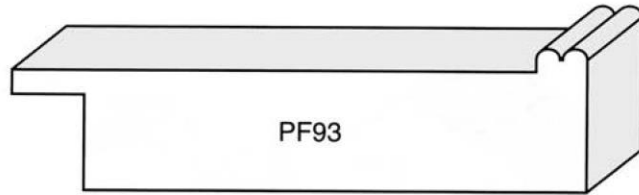

3/4" x 3"

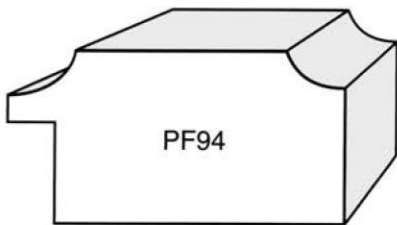

7/8" x 1-3/4"

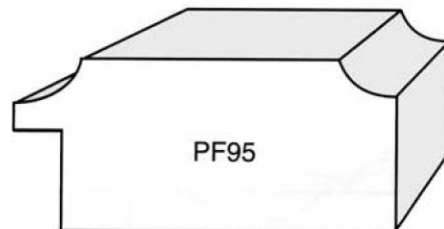

7/8" x 2"

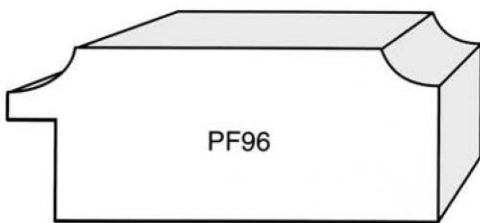

7/8" x 2-1/4"

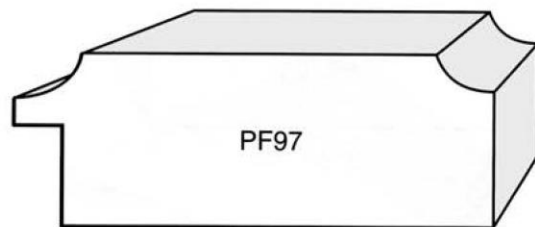

7/8" x 2-1/2"

PICTURE FRAME - Molding Patterns

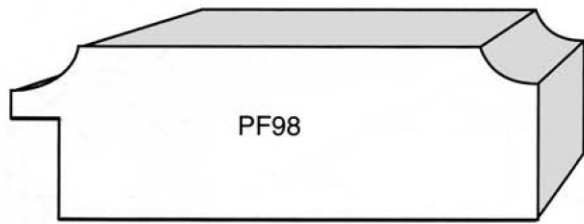

7/8" x 2-3/4"

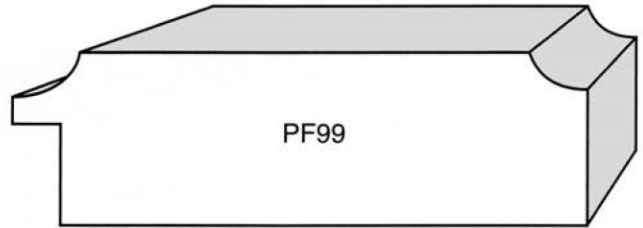

7/8" x 3"

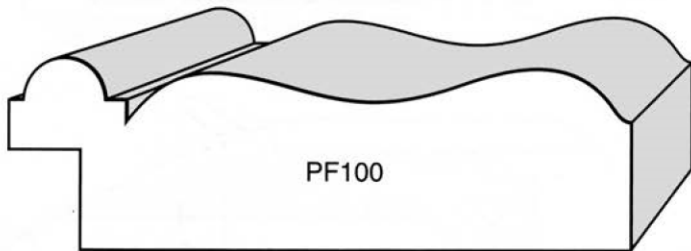

1" x 3-1/4"

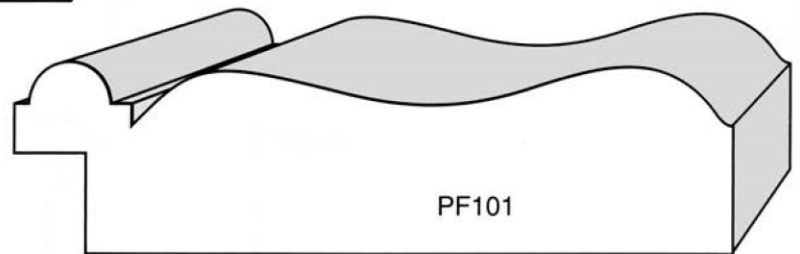

1" x 3-3/4"

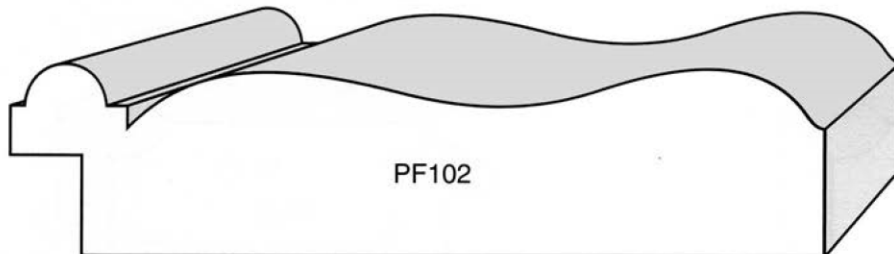

1" x 4-1/4"

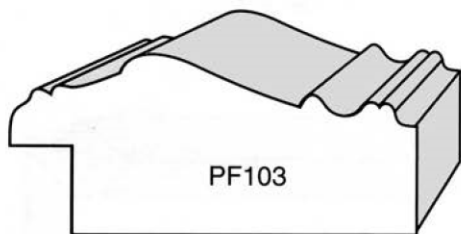

15/16" x 2-1/8"

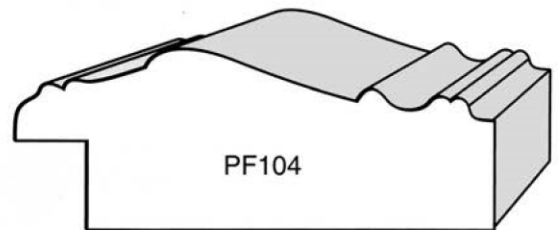

15/16" x 2-1/2"

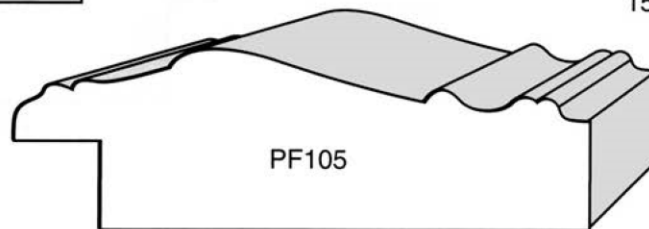

15/16" x 3"

Molding Patterns - PICTURE FRAME

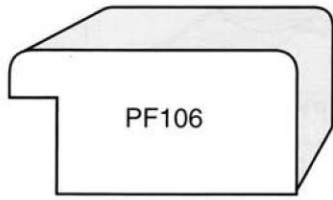

PF106

3/4" x 1-1/2"

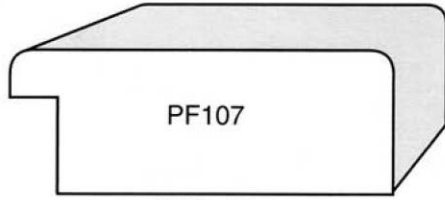

PF107

3/4" x 2"

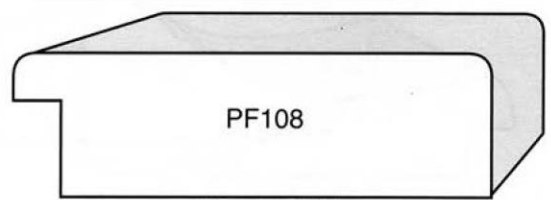

PF108

3/4" x 2-1/2"

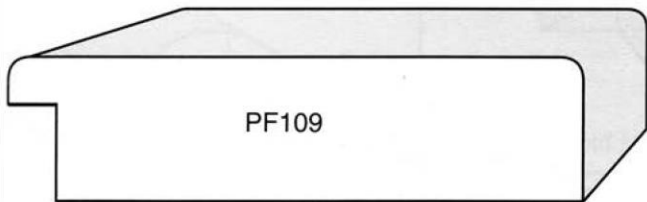

PF109

3/4" x 3"

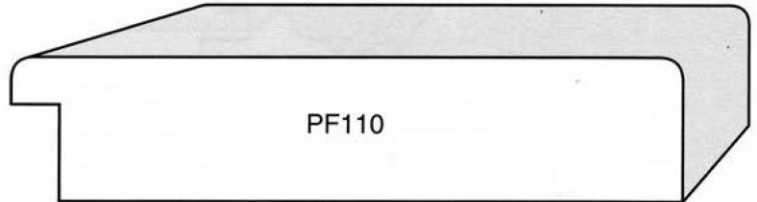

PF110

3/4" x 3-1/2"

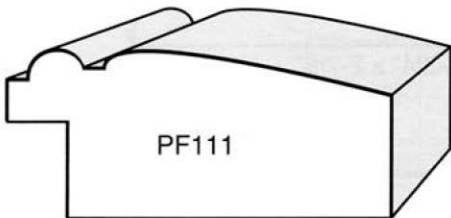

PF111

7/8" x 2"

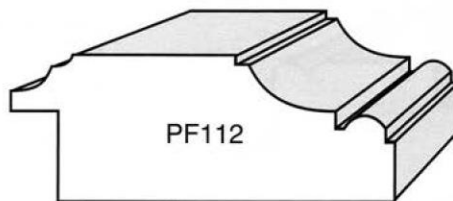

PF112

3/4" x 2"

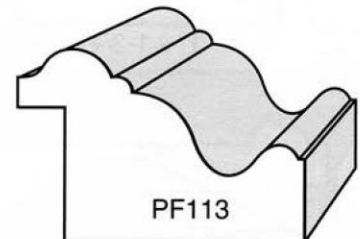

PF113

1" x 1-1/2"

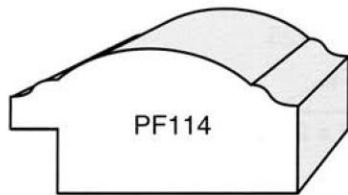

PF114

3/4" x 1-1/2"

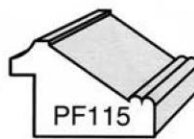

PF115

1/2" x 3/4"

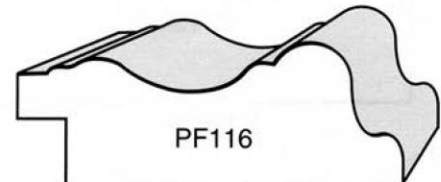

PF116

3/4" x 2"

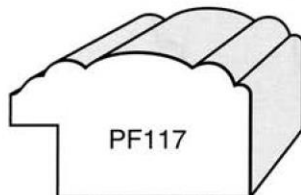

PF117

3/4" x 1-1/4"

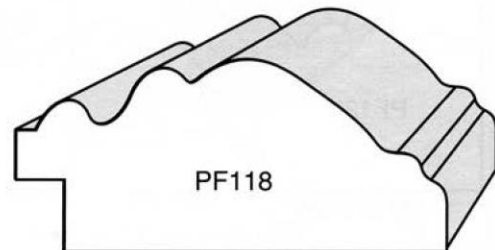

PF118

1" x 2-1/4"

PICTURE FRAME - Molding Patterns

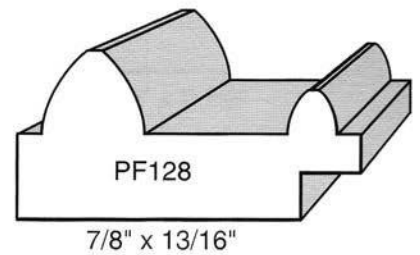
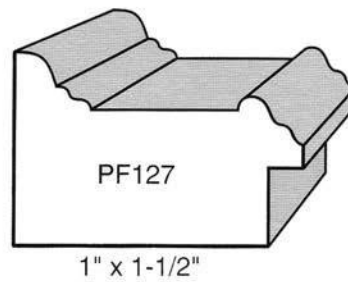
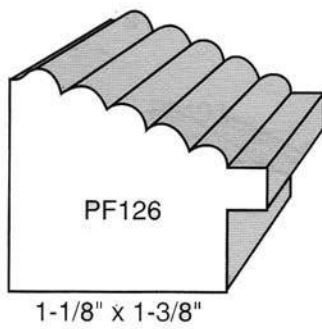
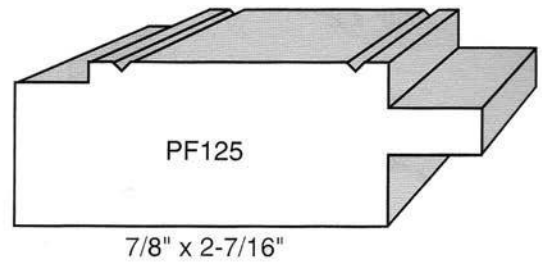
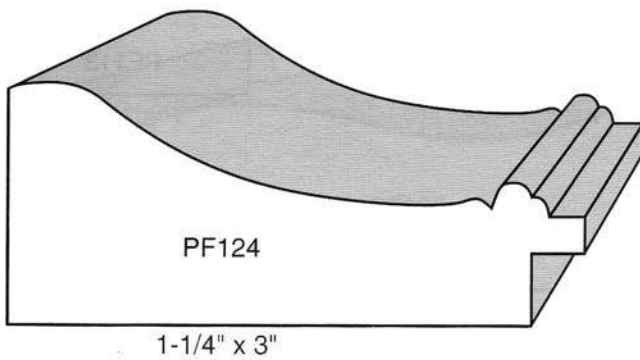
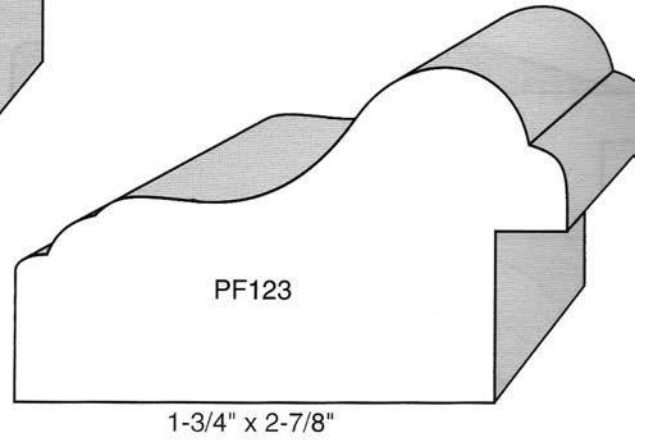
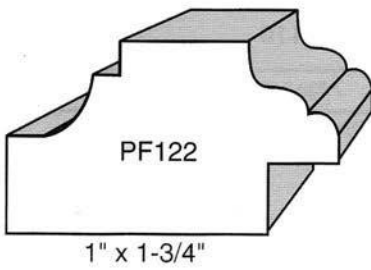
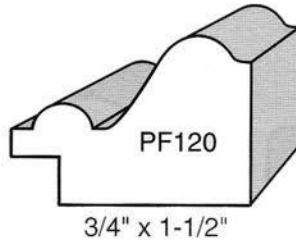
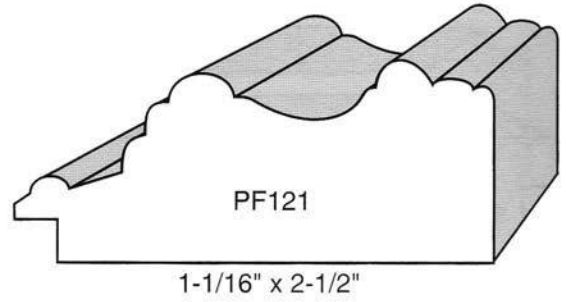
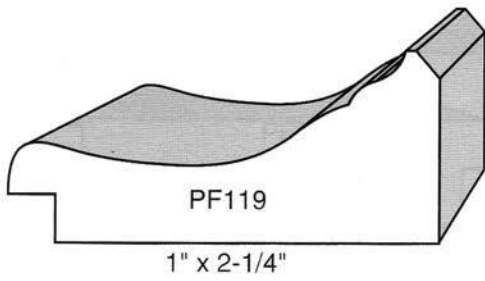

Molding Patterns - PICTURE FRAME

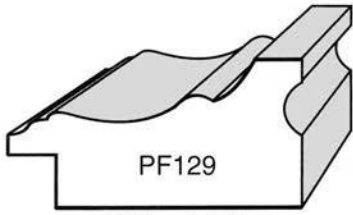

PF129

3/4" x 1-1/2"
(2 Knives)

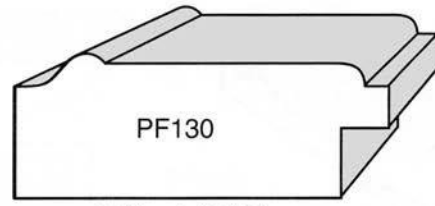

PF130

3/4" x 1-15/16"

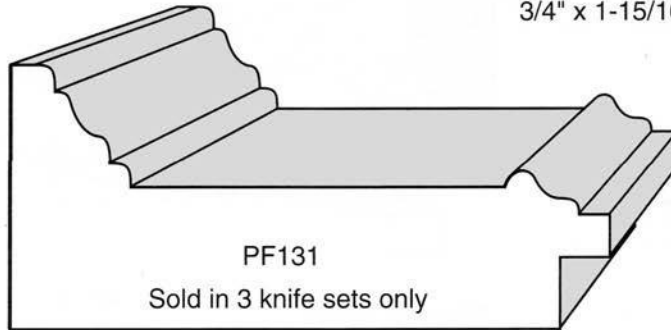

PF131

Sold in 3 knife sets only

1-3/8" x 3-1/8"

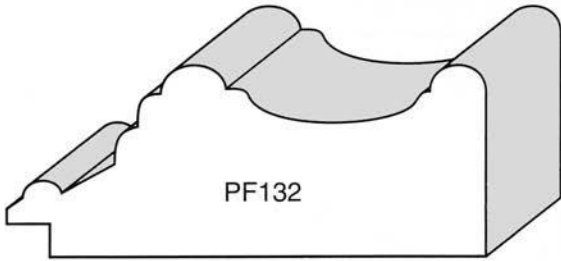

PF132

1" x 2-1/2"

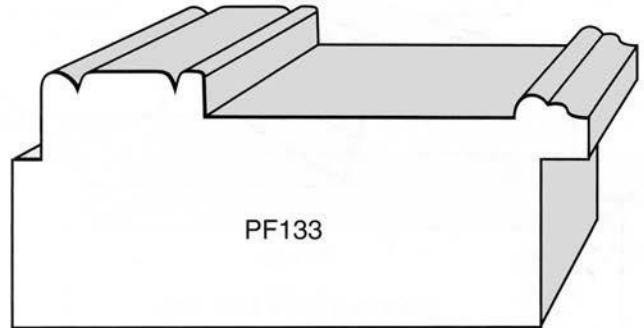

PF133

1-5/16" x 3"

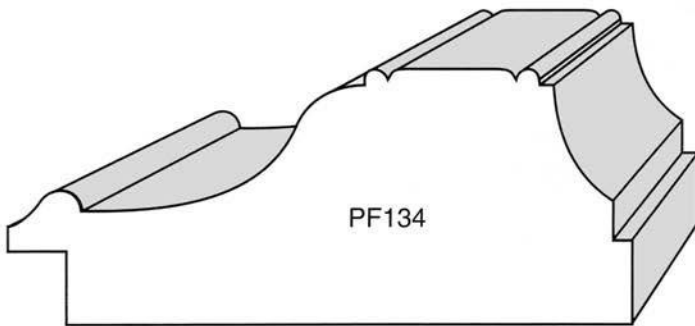

PF134

1-5/16" x 3-1/4"

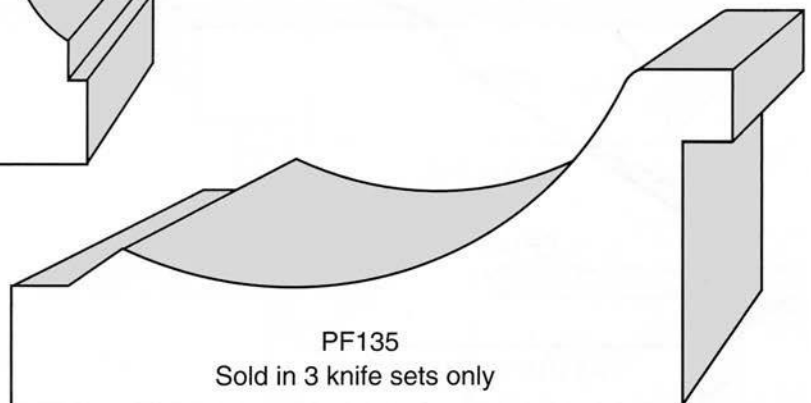

PF135

Sold in 3 knife sets only

1-3/4" x 3-3/4"

PICTURE FRAME - Molding Patterns

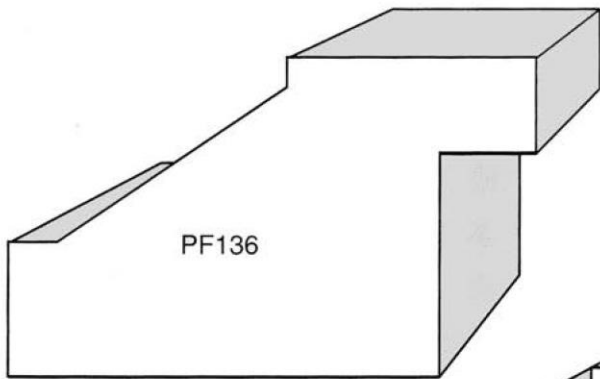

PF136

1-11/16" x 2-3/4"

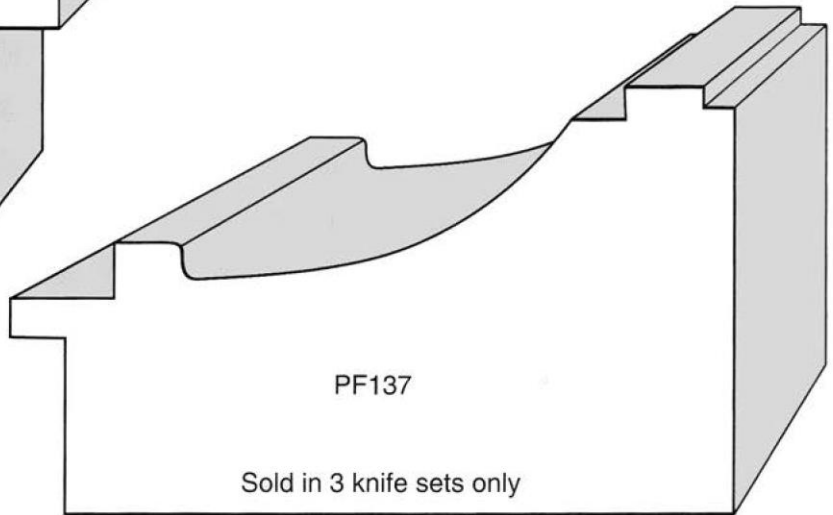

PF137

Sold in 3 knife sets only

2-1/4" x 3-3/4"

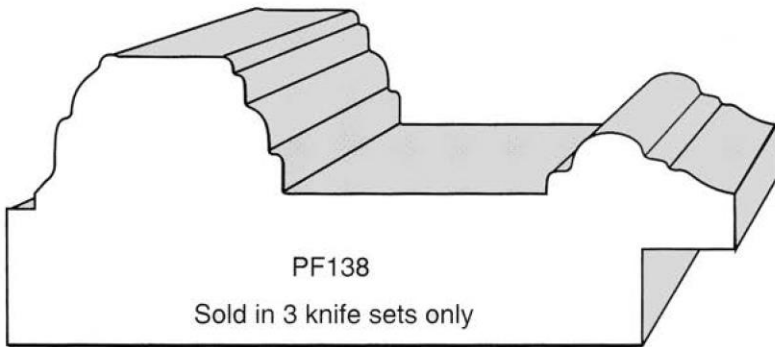

PF138

Sold in 3 knife sets only

1-1/2" x 3-3/4"

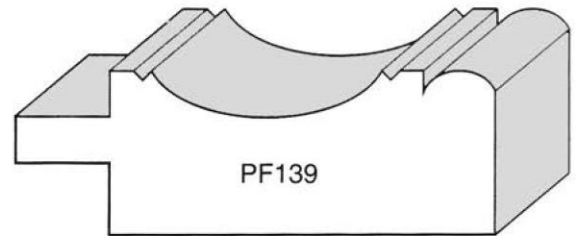

PF139

7/8" x 2-1/2"

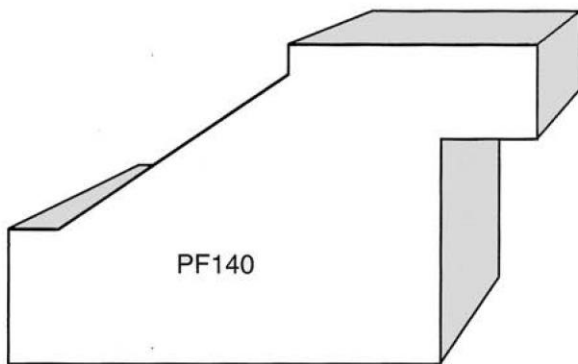

PF140

1-11/16" x 2-3/4"

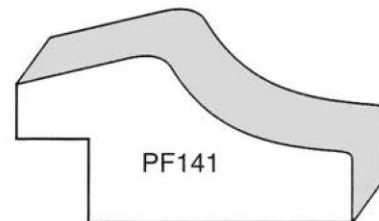

PF141

7/8" x 1-3/4"

Molding Patterns - PICTURE FRAME

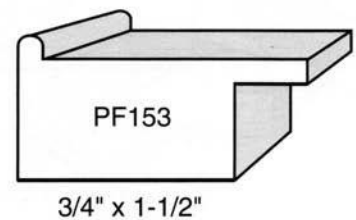
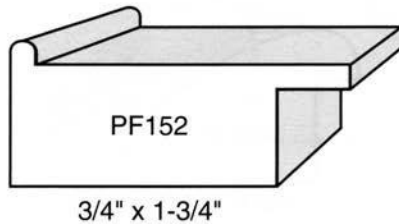
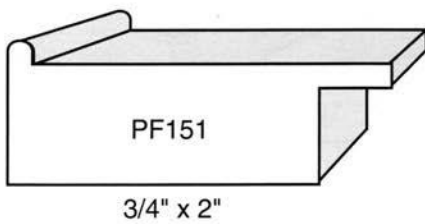
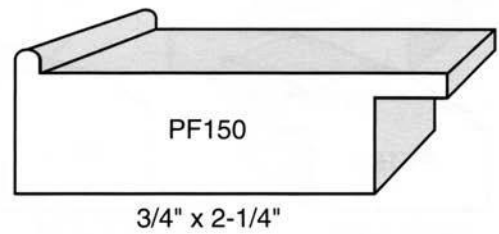
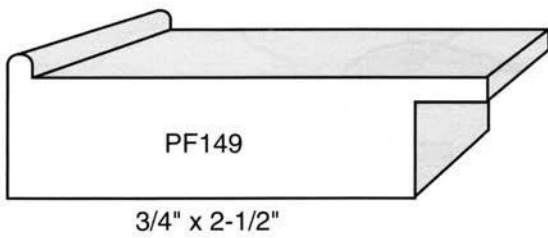
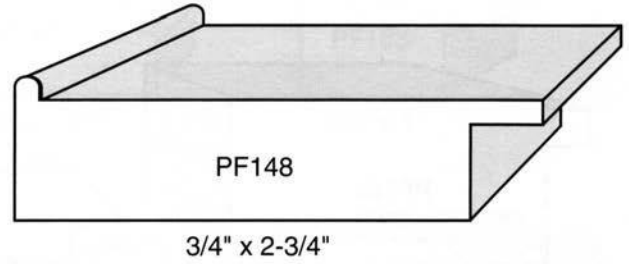
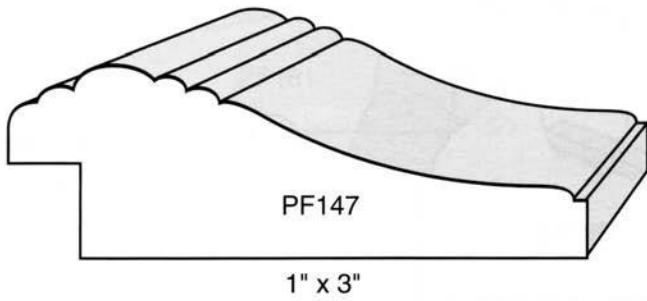
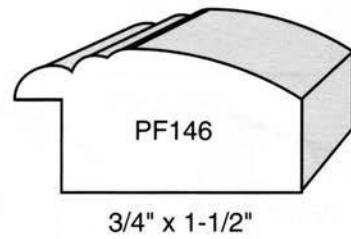
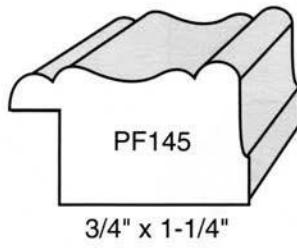
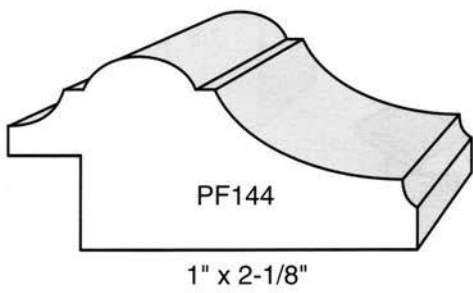
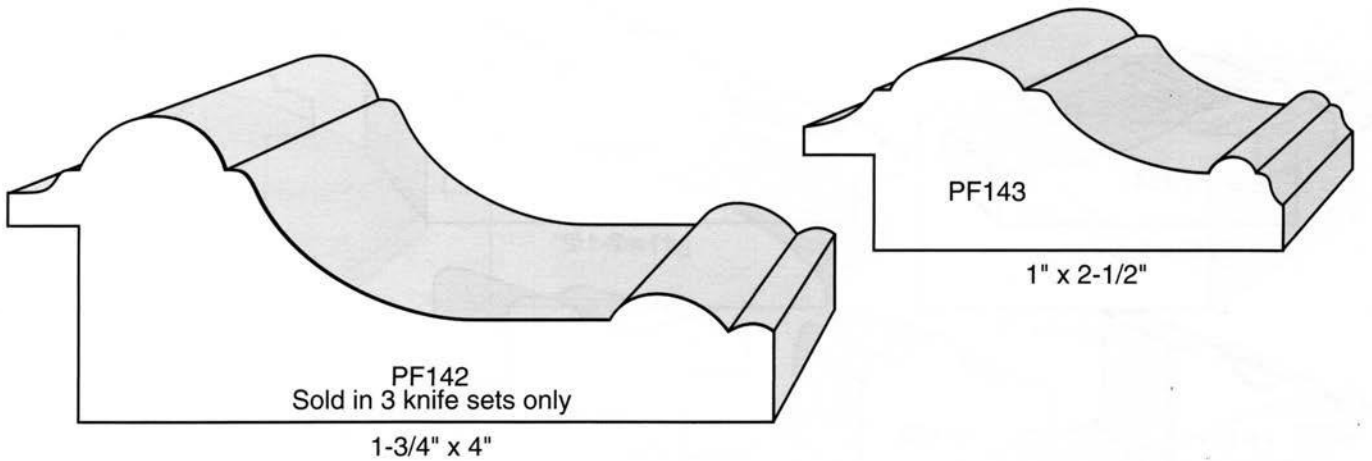

PICTURE FRAME - Molding Patterns

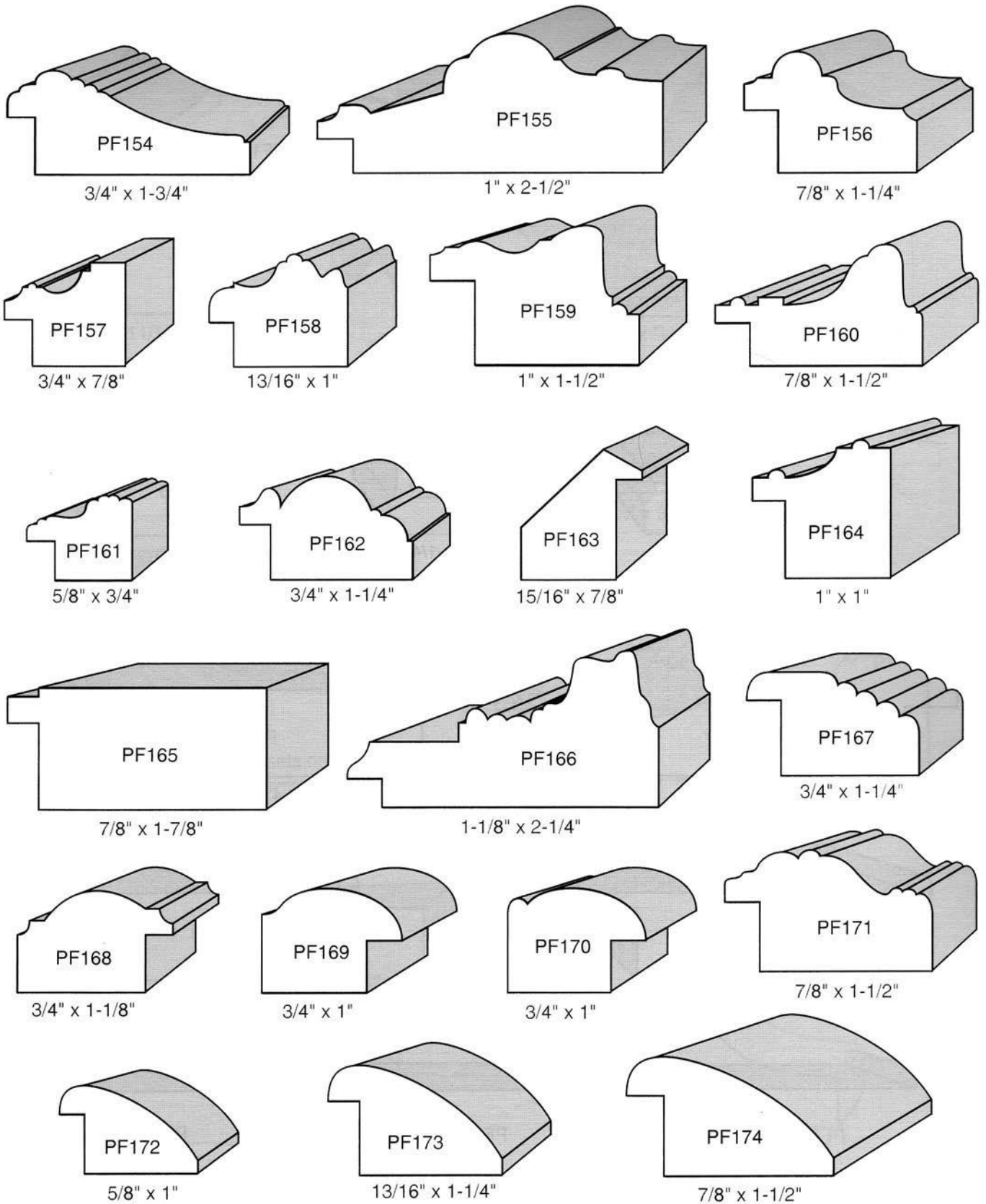

Molding Patterns - PICTURE FRAME

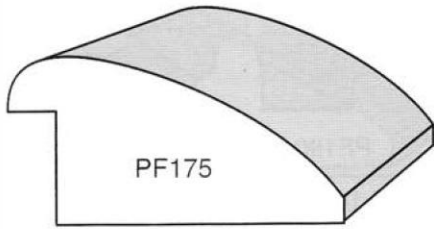

PF175

7/8" x 1-3/4"

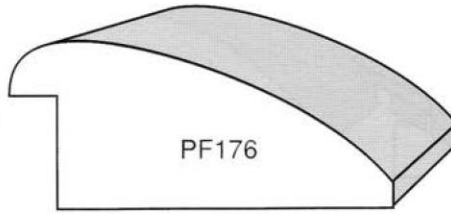

PF176

7/8" x 2"

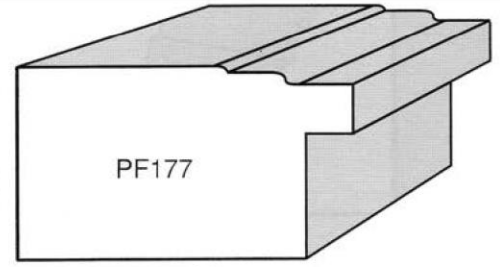

PF177

1" x 1-3/4"

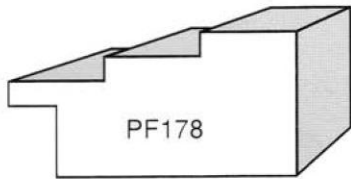

PF178

3/4" x 1-1/2"

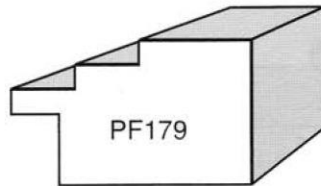

PF179

3/4" x 1-1/4"

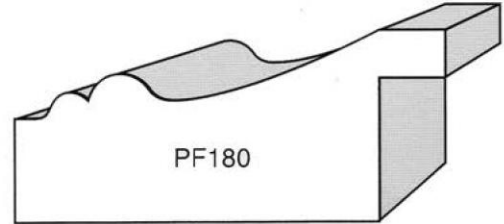

PF180

1" x 2-1/4"

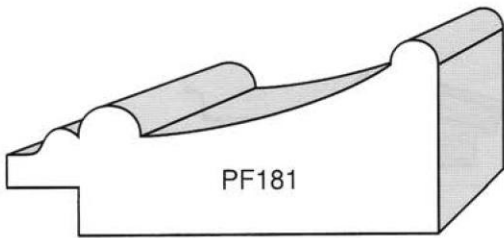

PF181

1" x 2-1/4"

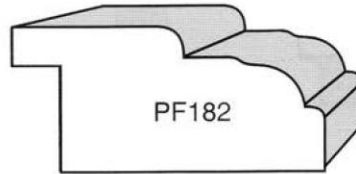

PF182

1-3/4" x 1-5/8"

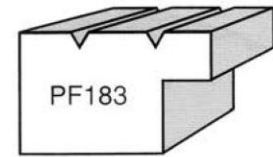

PF183

5/8" x 1"

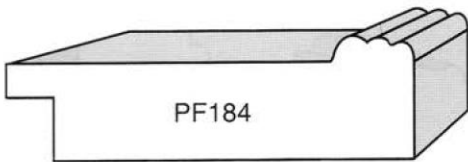

PF184

5/8" x 1-1/8"

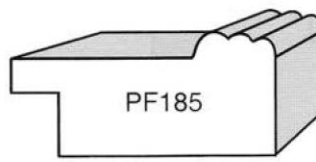

PF185

5/8" x 1-3/8"

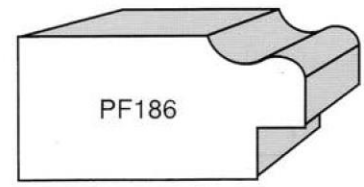

PF186

3/4" x 1-1/2"

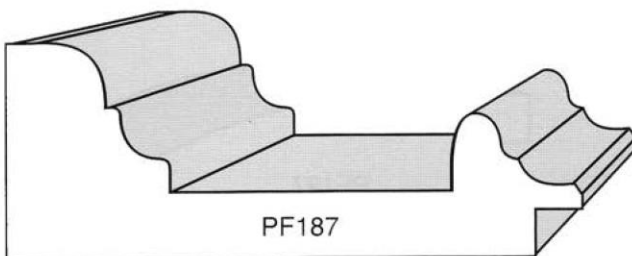

PF187

1-1/8" x 3"

Sold in 3 knife sets only

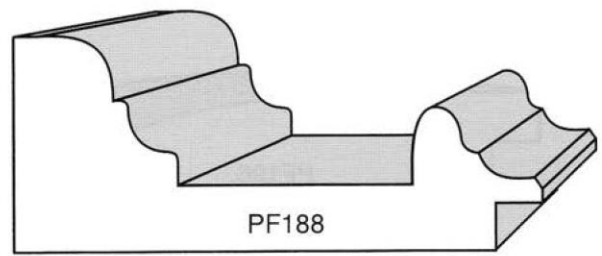

PF188

1-1/8" x 2-3/4"

Sold in 3 knife sets only

PICTURE FRAME - Molding Patterns

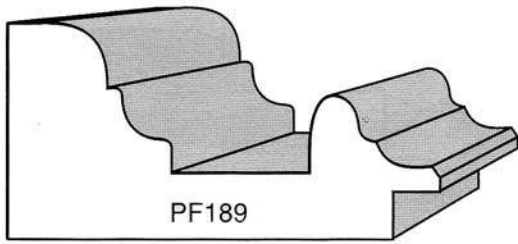

PF189
1-1/8" x 2-1/4"
Sold in 3 knife sets only

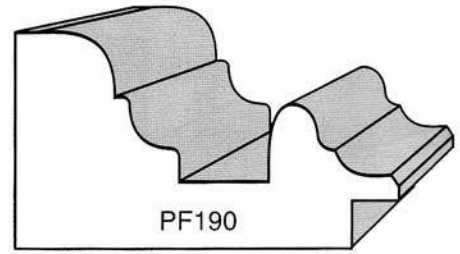

PF190
1-1/8" x 2"
Sold in 3 knife sets only

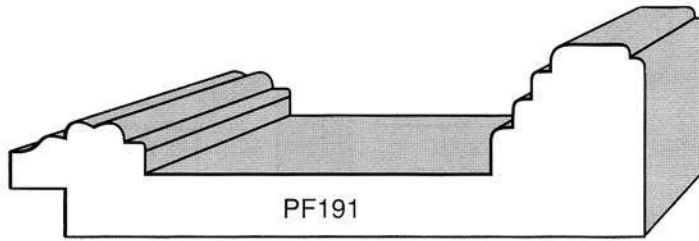

PF191
1" x 3-1/4"
Sold in 3 knife sets only

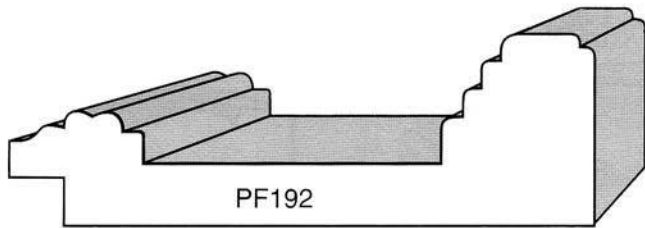

PF192
1" x 3"
Sold in 3 knife sets only

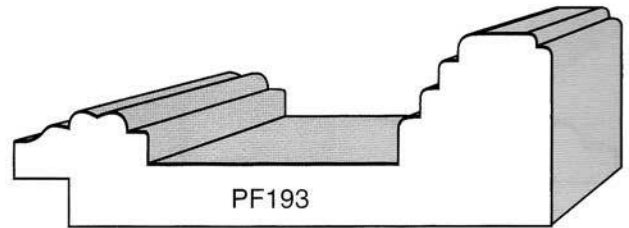

PF193
1" x 2-3/4"
Sold in 3 knife sets only

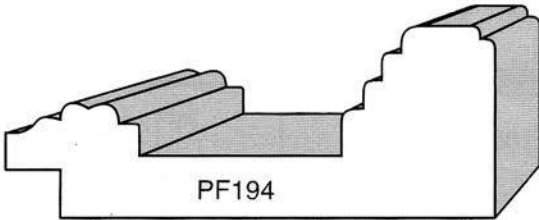

PF194
1" x 2-1/2"
Sold in 3 knife sets only

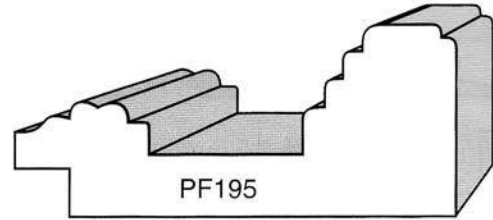

PF195
1" x 2-1/4"
Sold in 3 knife sets only

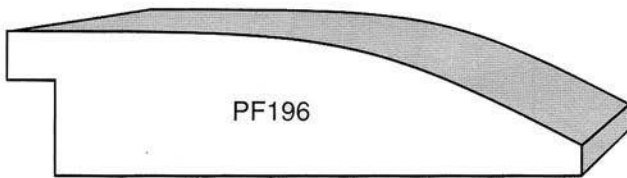

PF196
3/4" x 3"

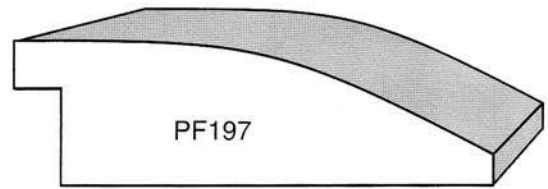

PF197
3/4" x 2-1/2"

Molding Patterns - PICTURE FRAME

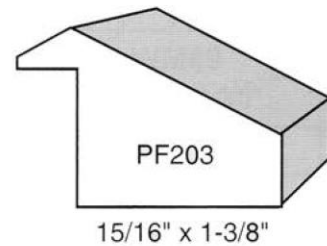
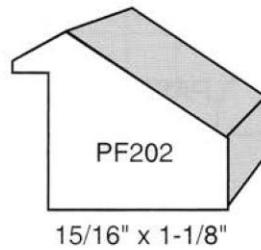
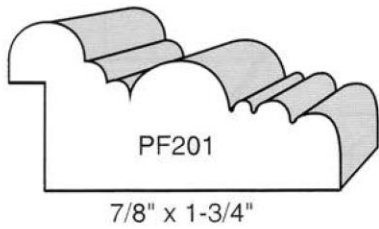
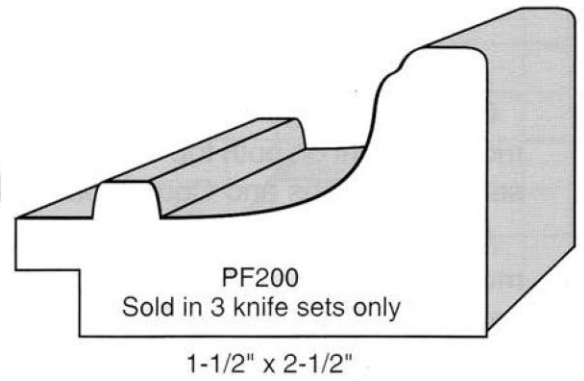
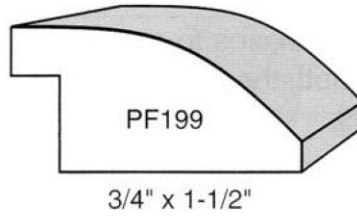
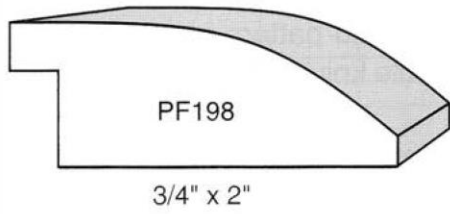

CROWN - Molding Patterns

Crown molding gives elegance and a mark of quality to a room. It "crowns" a room at the point where walls meet the ceiling, unifying a room while lending handsome detail and finished quality. The inside corner is "sprung," or cut off to better fit into a 90-degree corner.

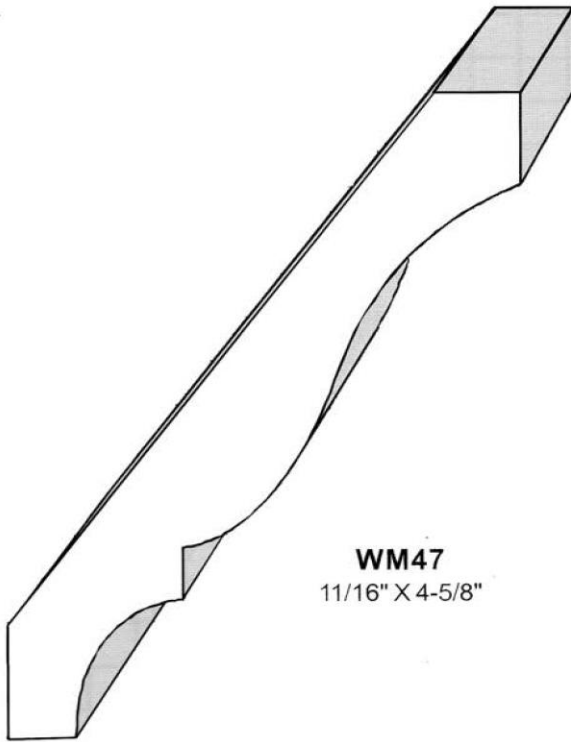

WM47
11/16" X 4-5/8"

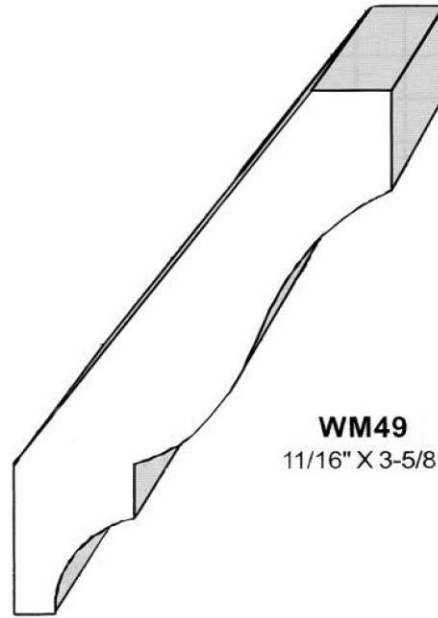

WM49
11/16" X 3-5/8"

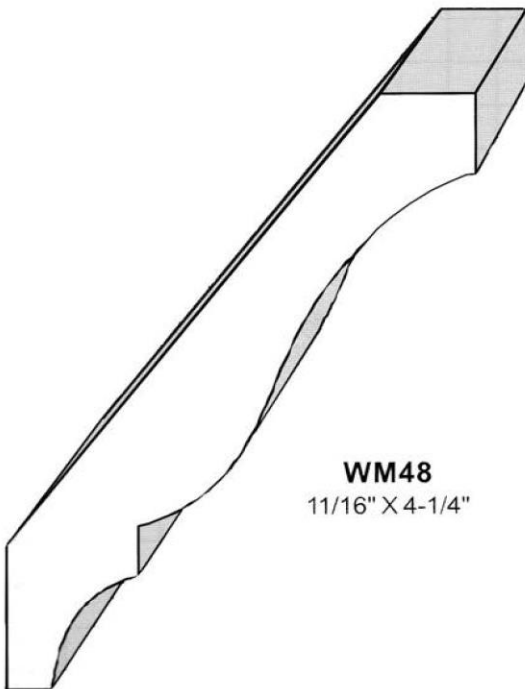

WM48
11/16" X 4-1/4"

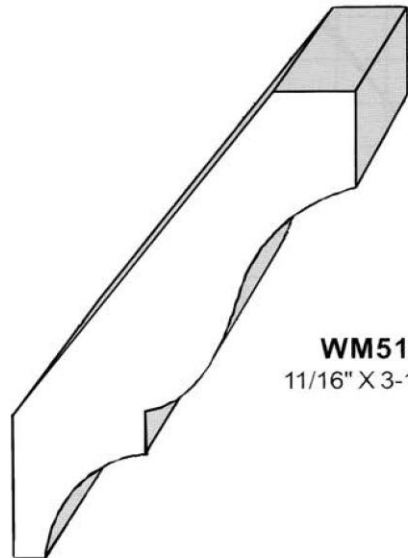

WM51
11/16" X 3-1/4"

Molding Patterns - CROWN

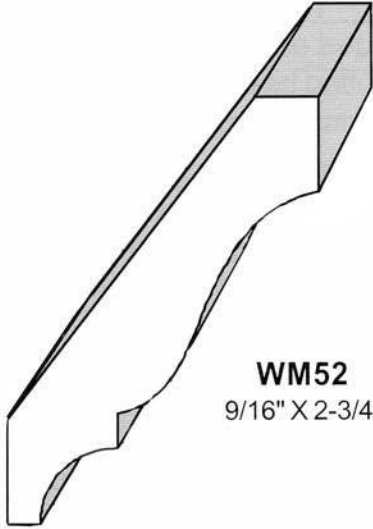

WM52
9/16" X 2-3/4"

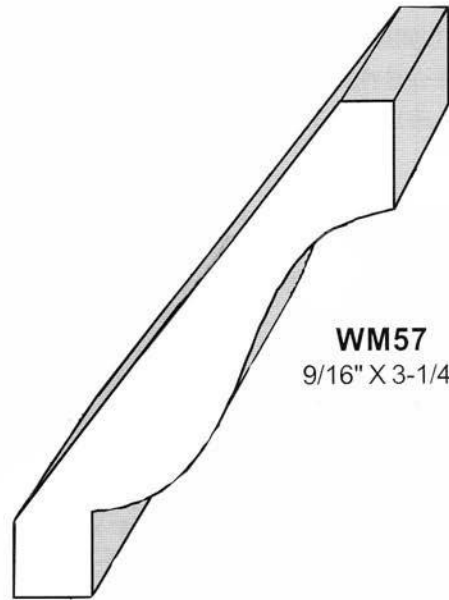

WM57
9/16" X 3-1/4"

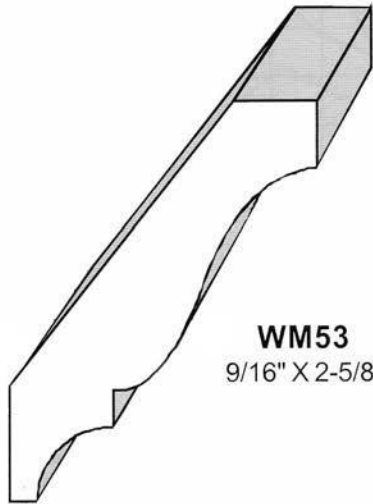

WM53
9/16" X 2-5/8"

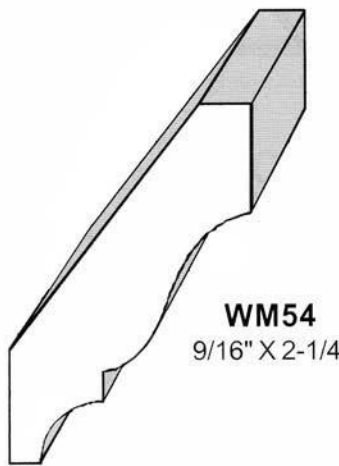

WM54
9/16" X 2-1/4"

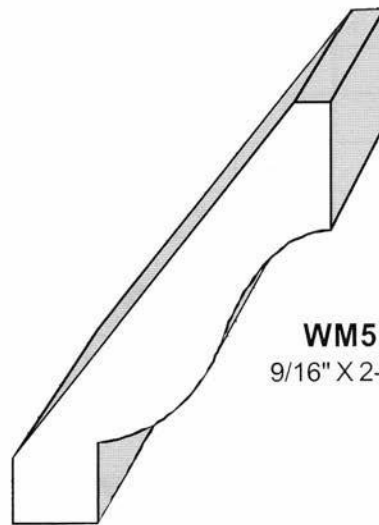

WM58
9/16" X 2-3/4"

CROWN - Molding Patterns

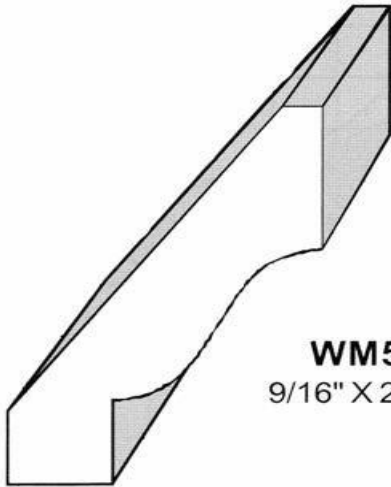

WM59
9/16" X 2-1/4"

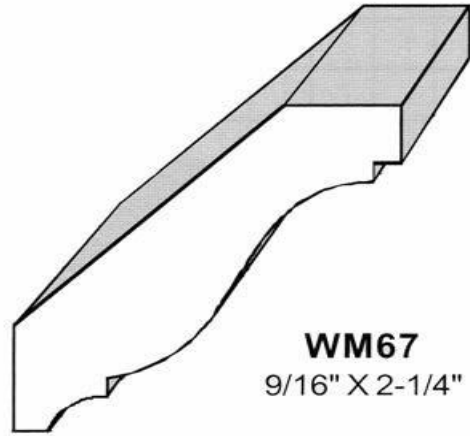

WM67
9/16" X 2-1/4"

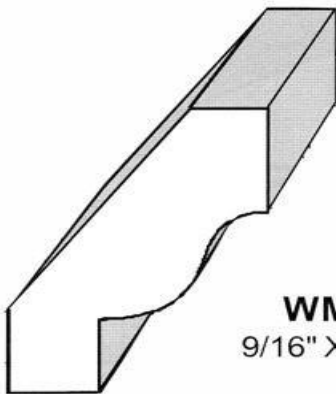

WM60
9/16" X 1-3/4"

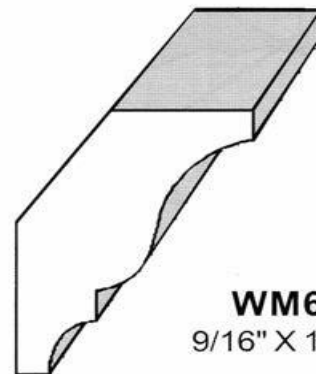

WM68
9/16" X 1-5/8"

Molding Patterns - CROWN

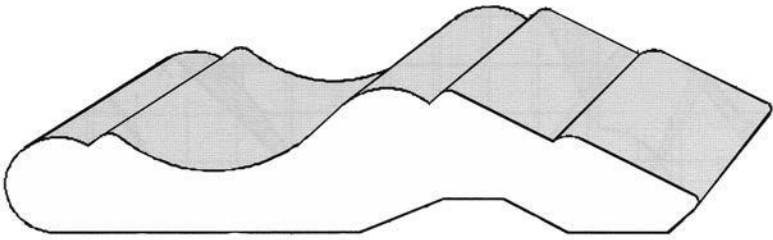

WM4100
3/4" X 3-5/8"

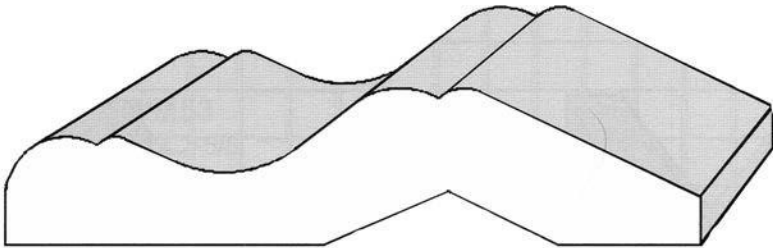

WM4101
3/4" X 3-5/8"

CROWN - Molding Patterns

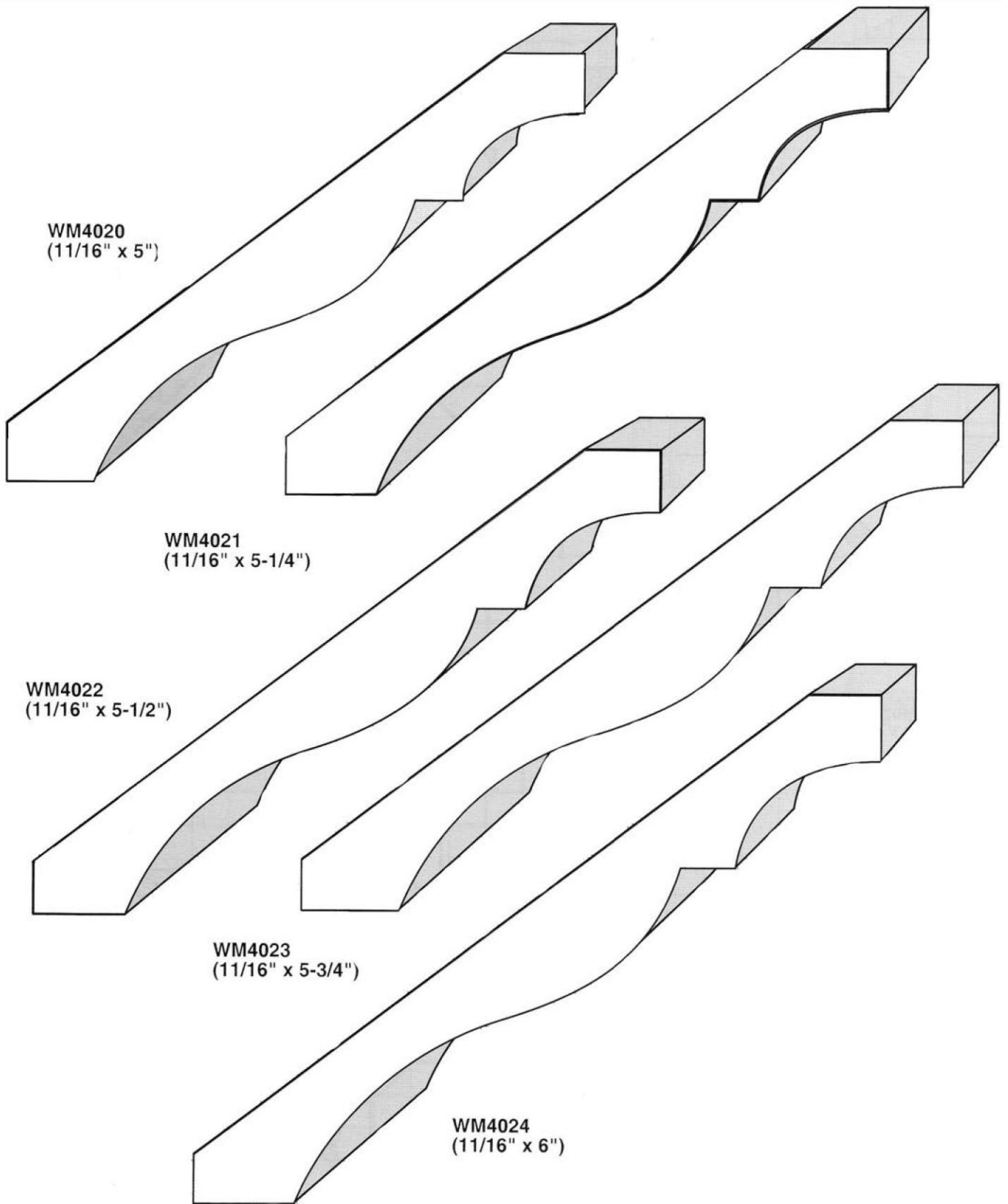

Molding Patterns - CROWN

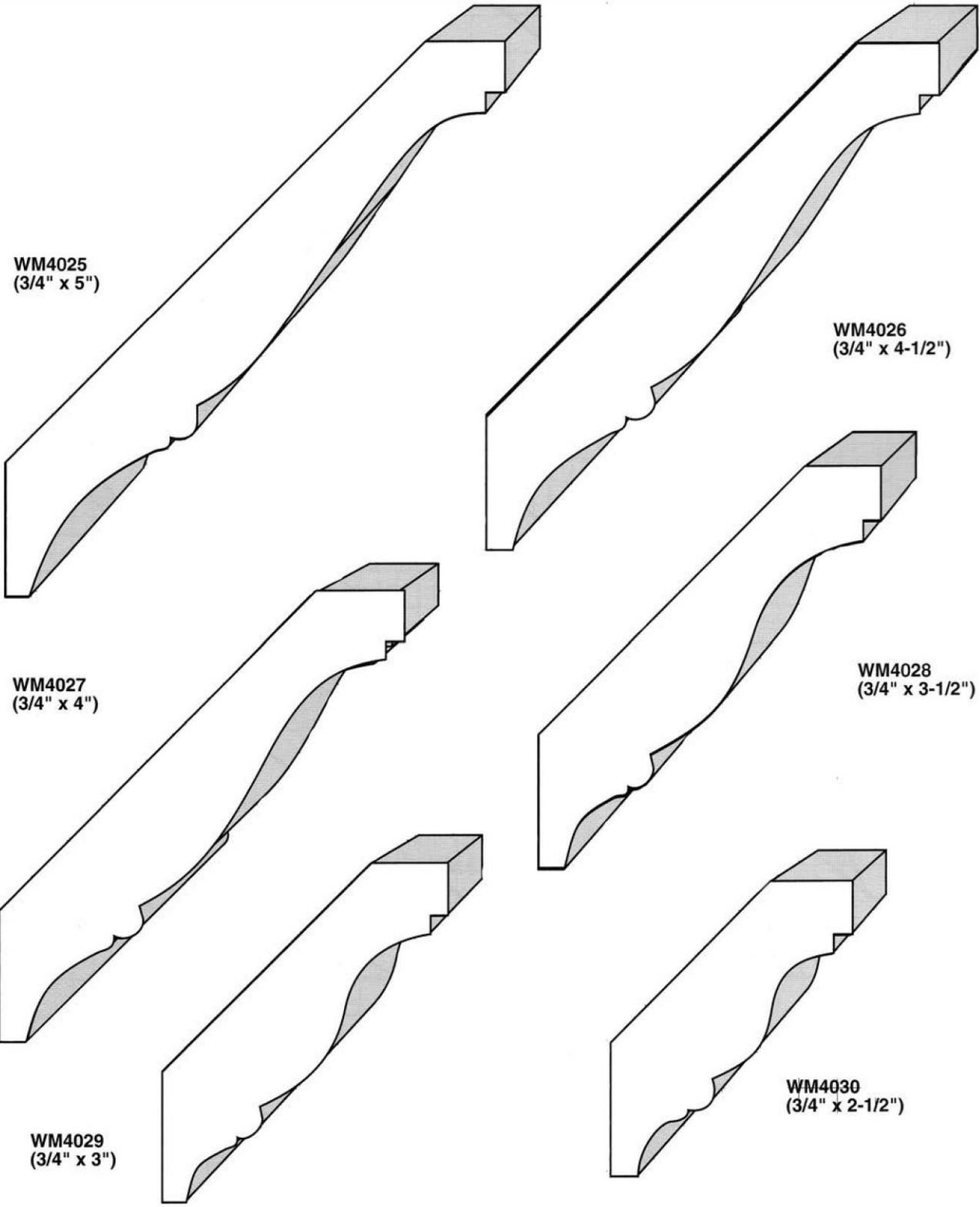

CROWN - Molding Patterns

WM4031
(3/4" x 5")

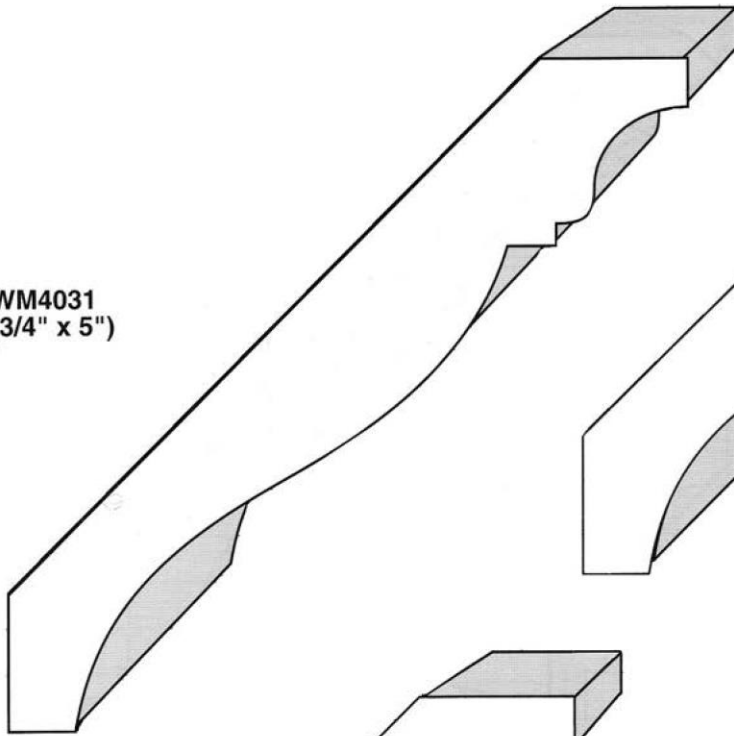

WM4032
(3/4" x 4-1/2")

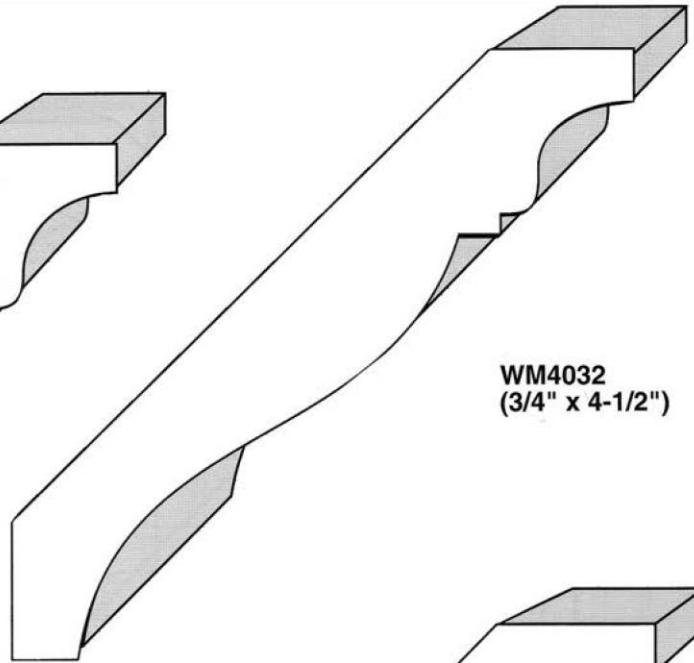

WM4033
(3/4" x 4")

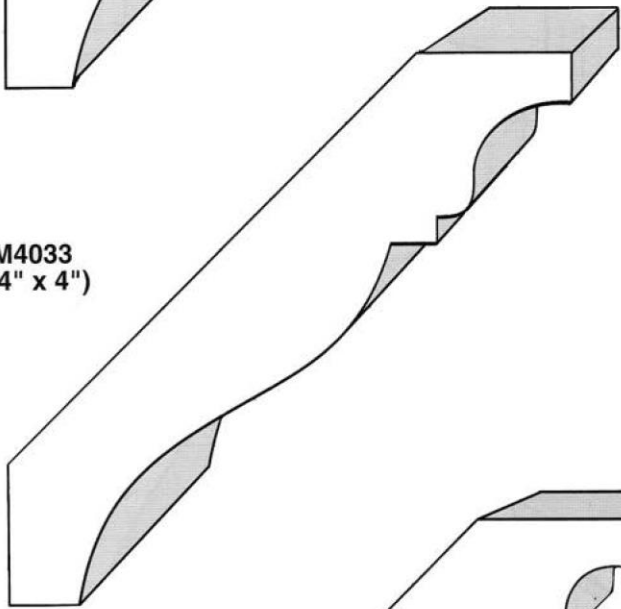

WM4034
(3/4" x 3-1/2")

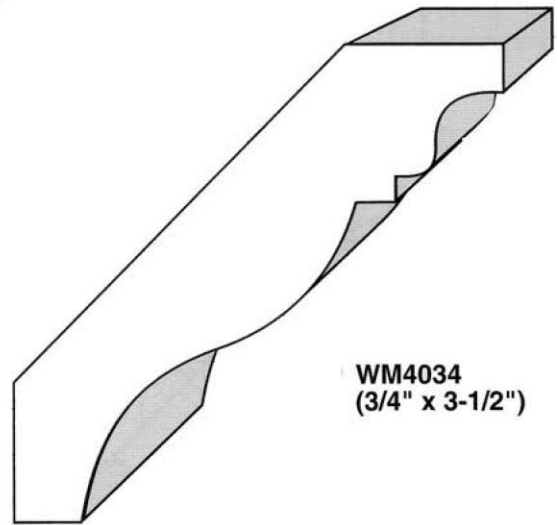

WM4035
(3/4" x 3")

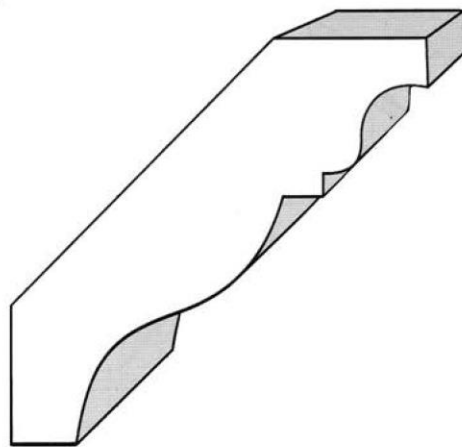

WM4036
(3/4" x 2-1/2")

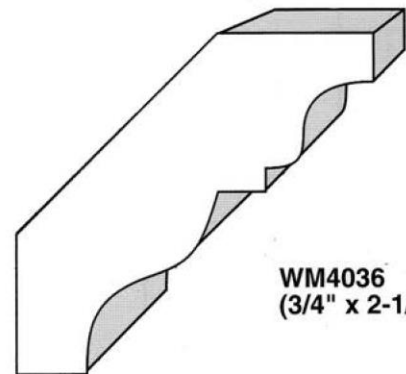

Molding Patterns - CROWN

WM4037
(3/4" x 4-1/2")

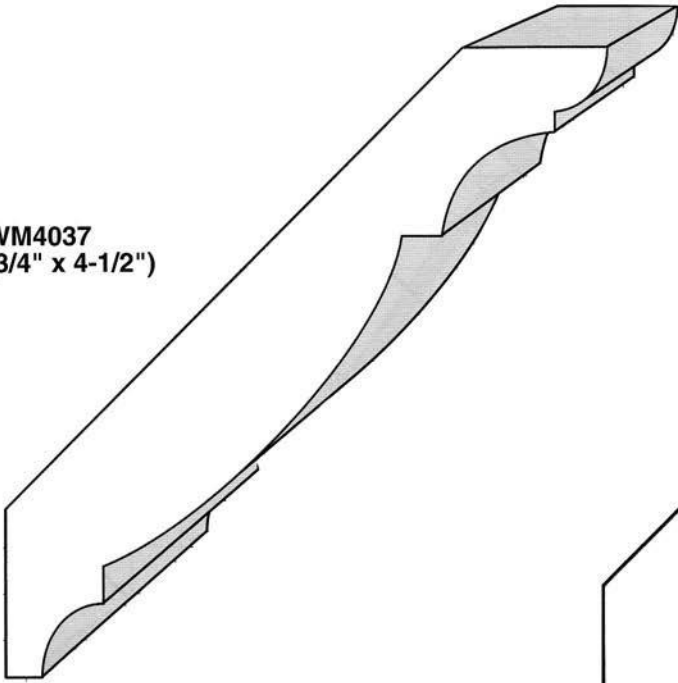

WM4038
(3/4" x 4")

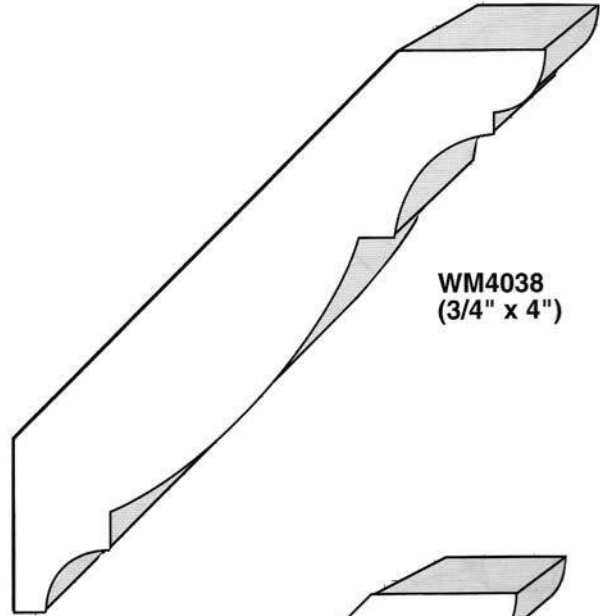

WM4039
(3/4" x 3-1/2")

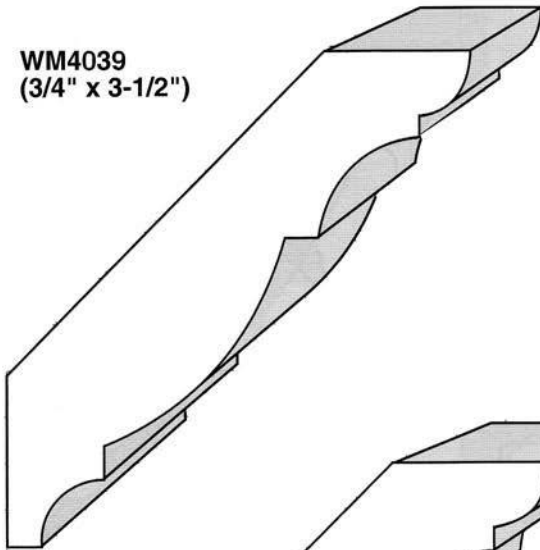

WM4040
(3/4" x 3")

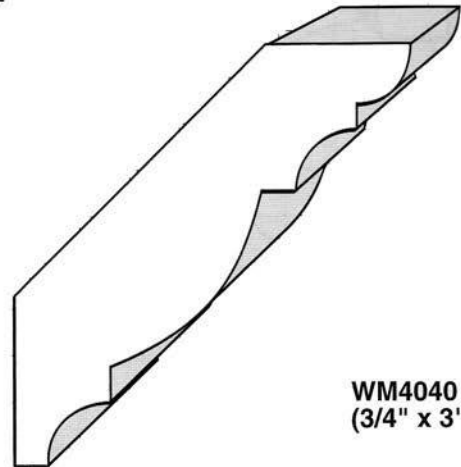

WM4041
(3/4" x 2-1/2")

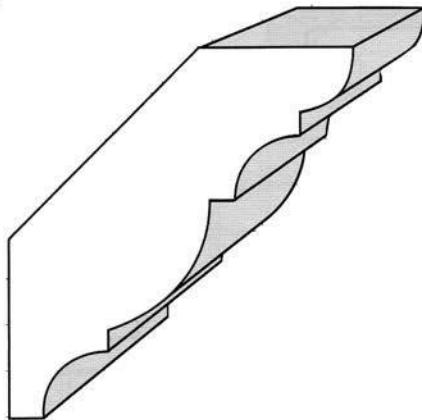

CROWN - Molding Patterns

WM4042
(3/4" x 5")

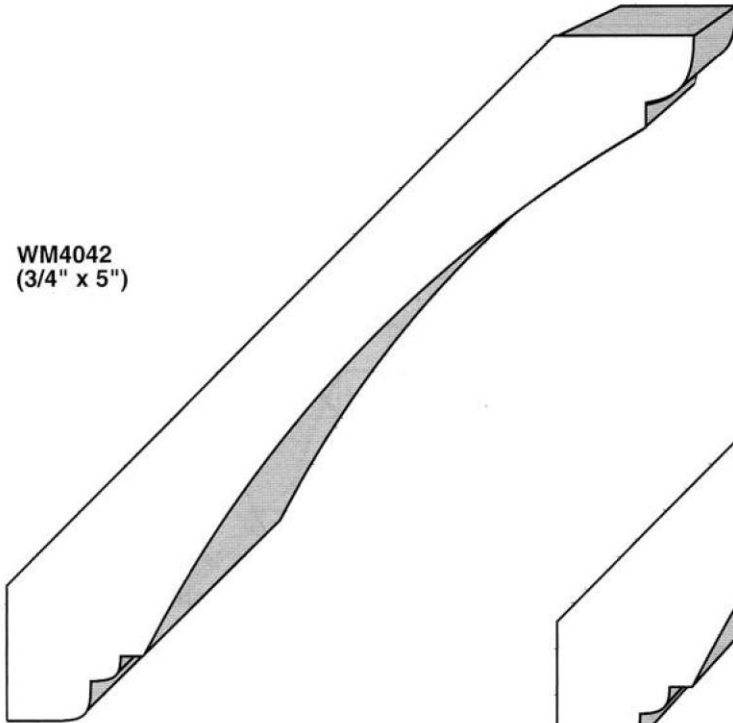

WM4043
(3/4" x 4-1/2")

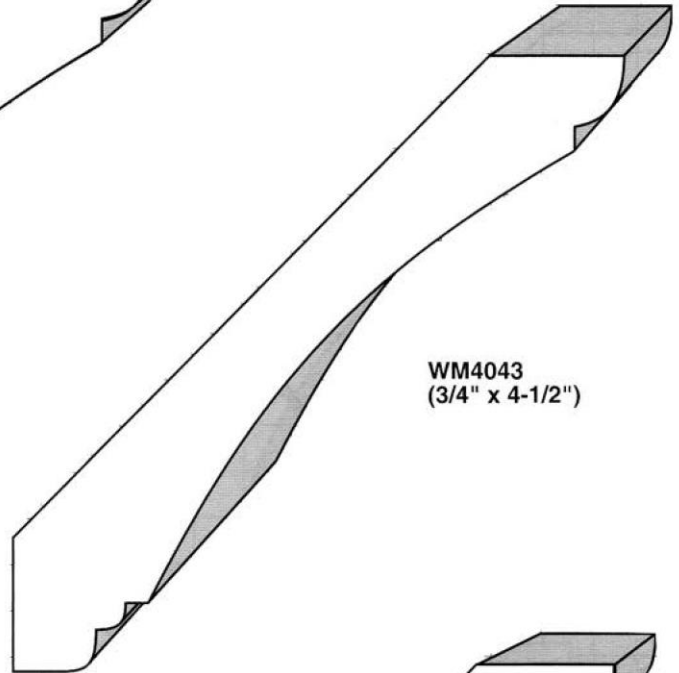

WM4044
(3/4" x 4")

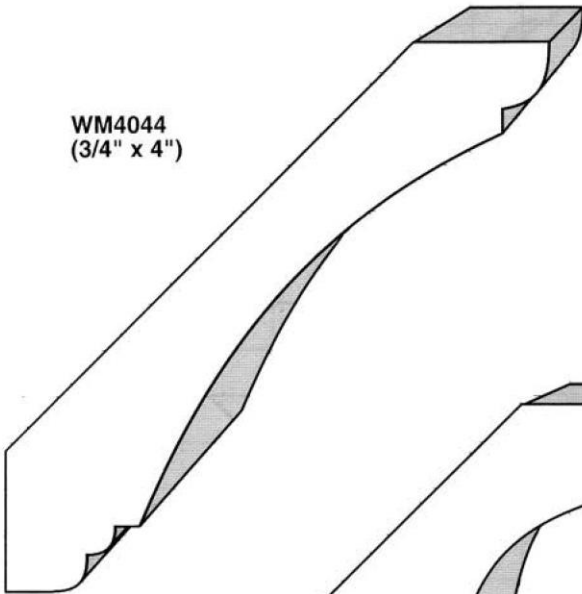

WM4045
(3/4" x 3-1/2")

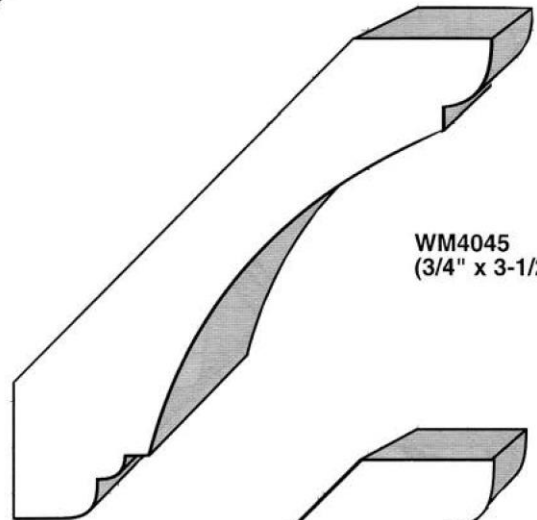

WM4047
(3/4" x 2-1/2")

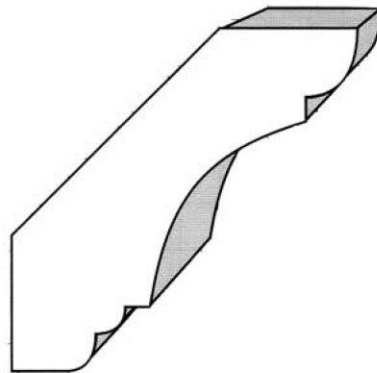

WM4046
(3/4" x 3")

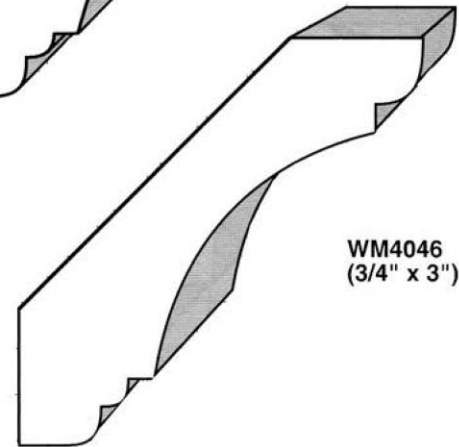

Molding Patterns - CROWN

WM4048
(3/4" x 5")

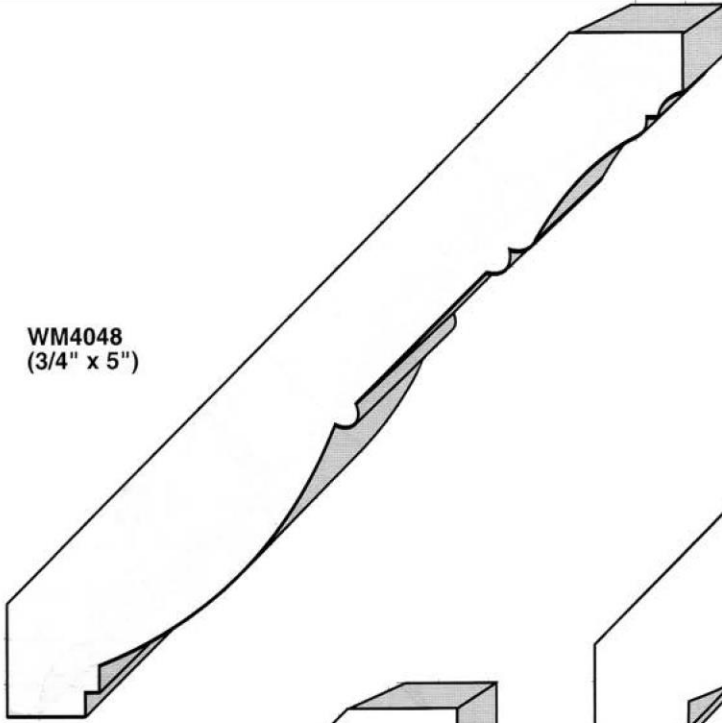

WM4049
(3/4" x 4-1/2")

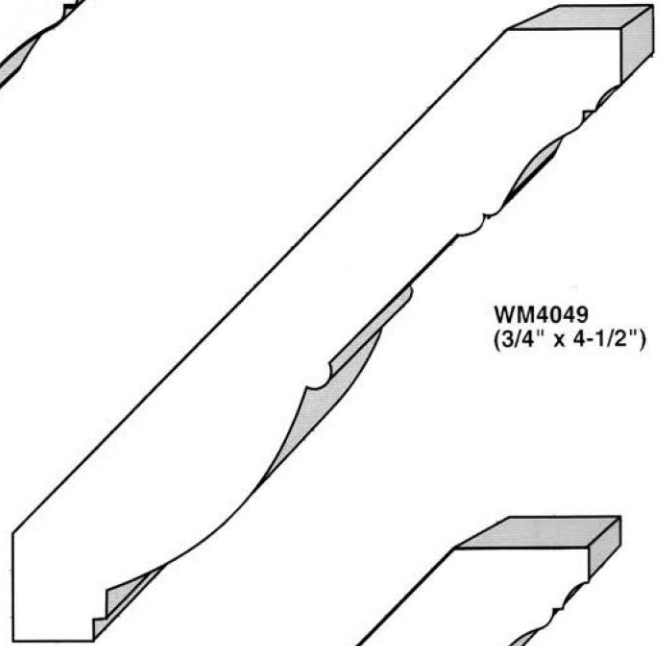

WM4050
(3/4" x 4")

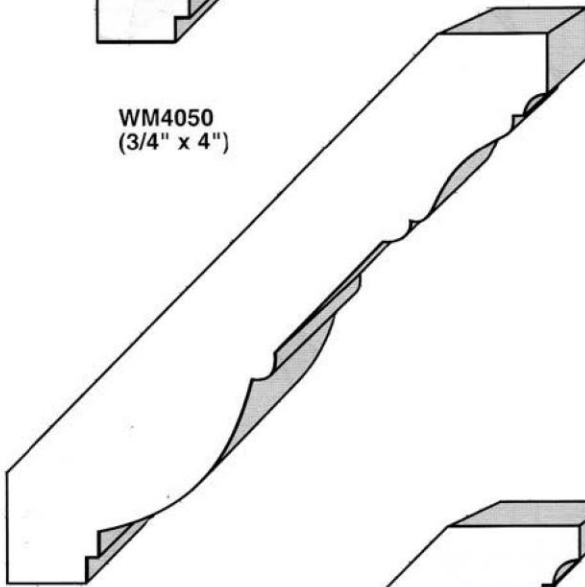

WM4051
(3/4" x 3-1/2")

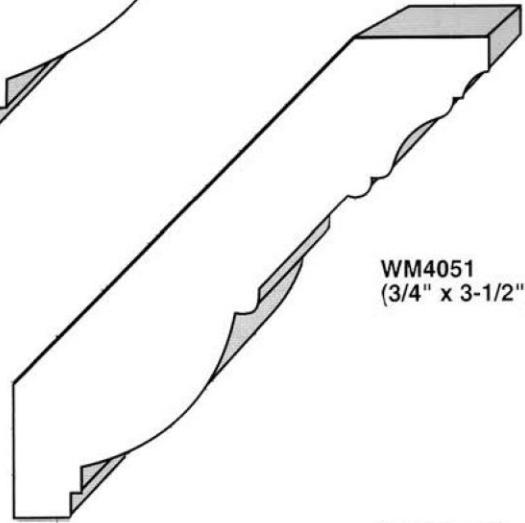

WM4052
(3/4" x 3")

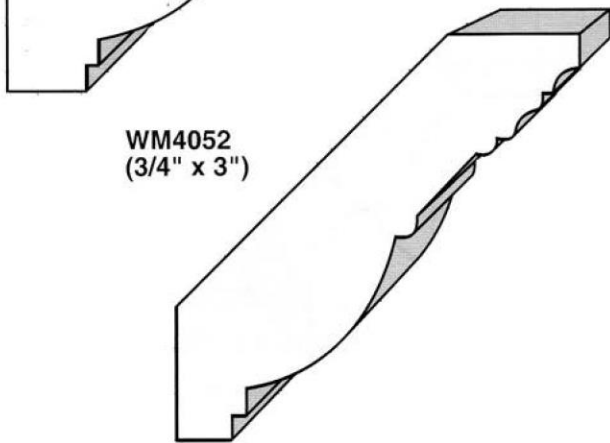

WM4053
(3/4" x 2-1/2")

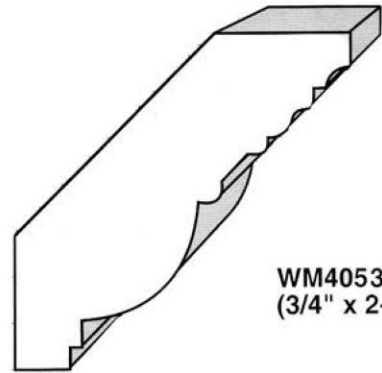

CROWN - Molding Patterns

WM4054
(3/4" x 5")

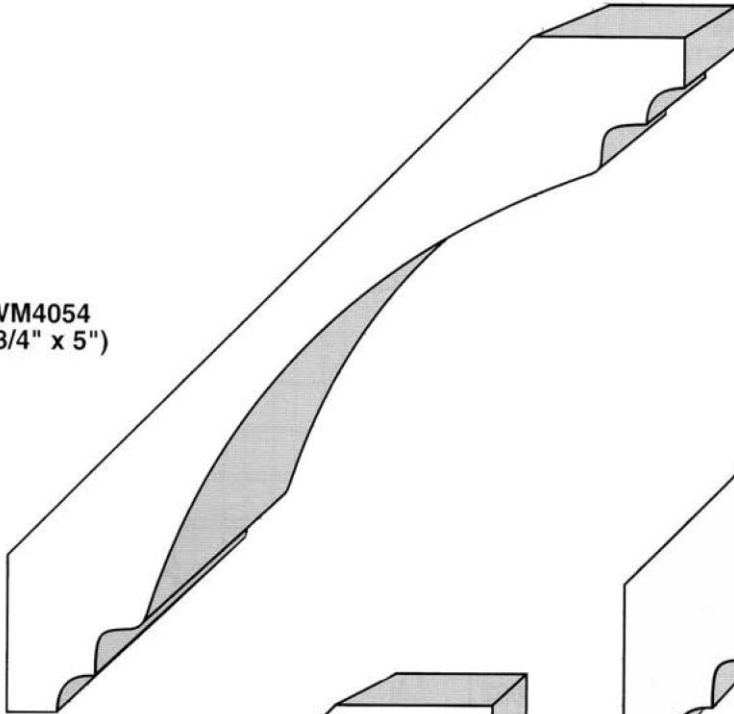

WM4055
(3/4" x 4-1/2")

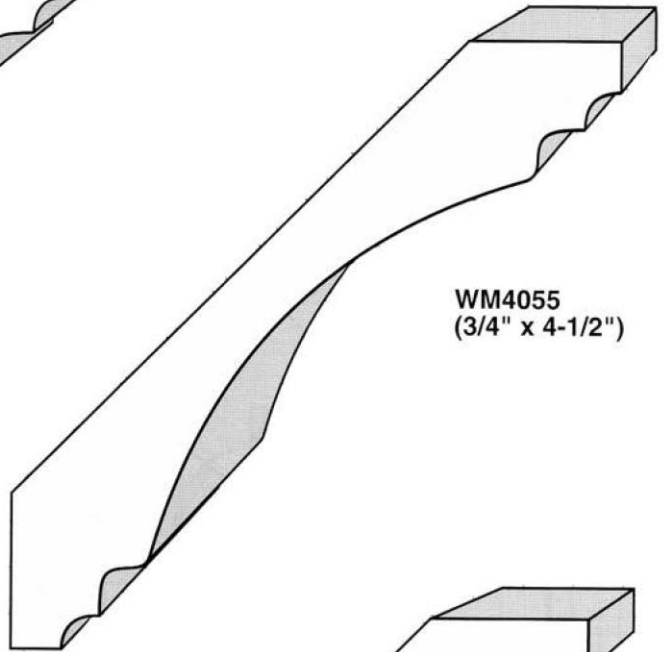

WM4056
(3/4" x 4")

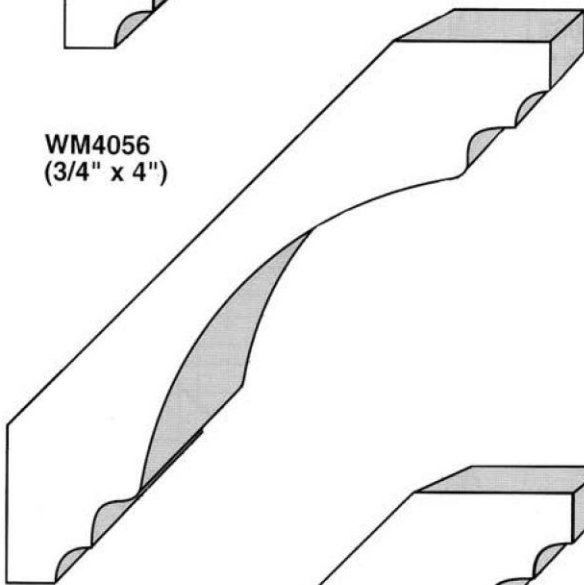

WM4057
(3/4" x 3-1/2")

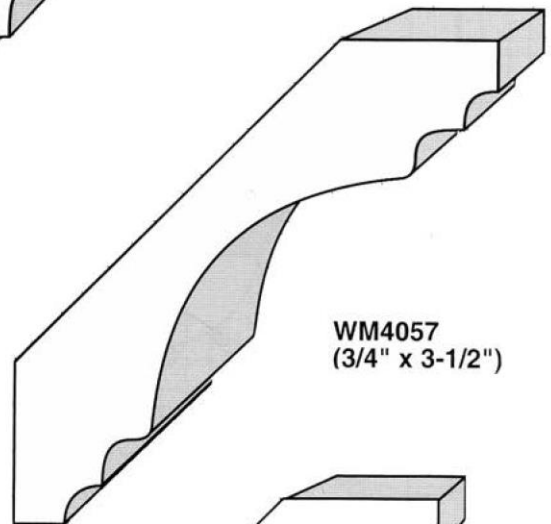

WM4058
(3/4" x 3")

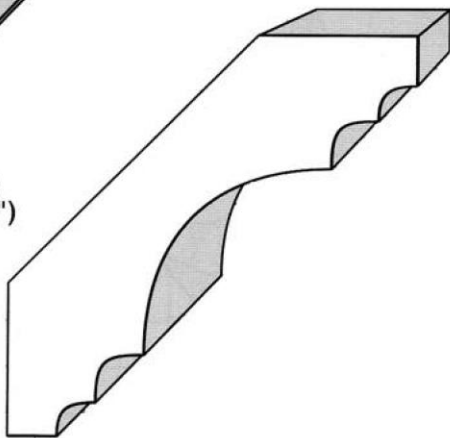

WM4059
(3/4" x 2-1/2")

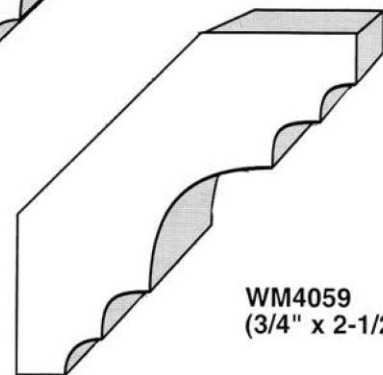

Molding Patterns - CROWN

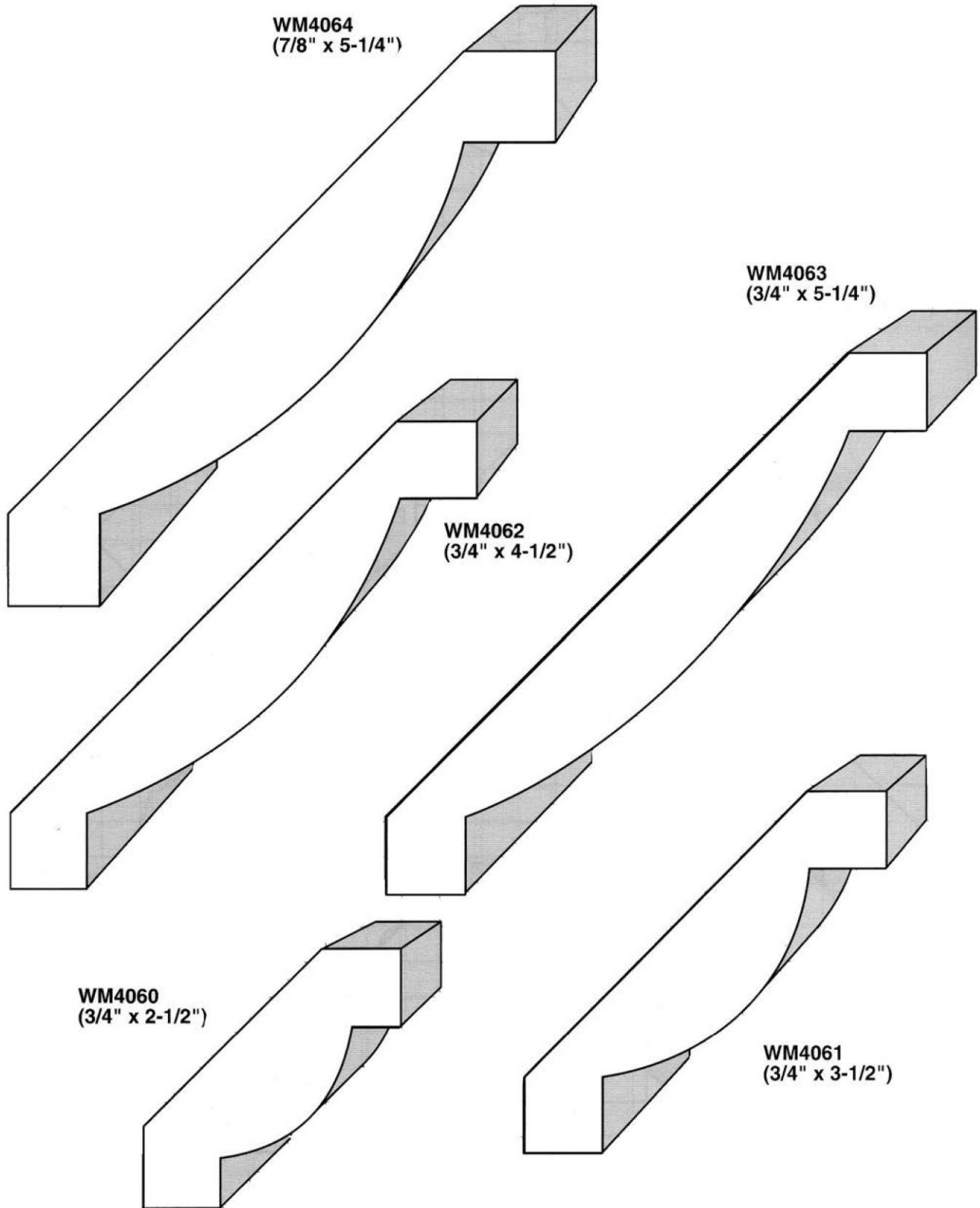

Molding Patterns - BED MOLDING

Bed Molding is commonly used like crown molding, where walls meet the ceiling. It is smaller in dimension, however, making it well suited for adding a finishing touch to a smaller or simpler room.

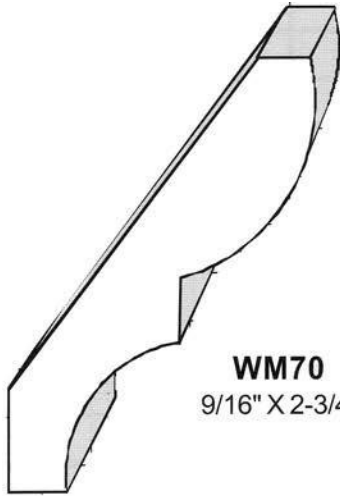

WM70
9/16" X 2-3/4"

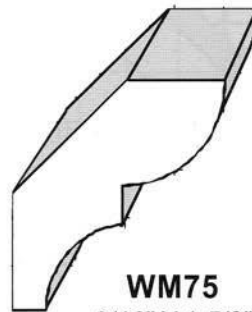

WM75
9/16" X 1-5/8"

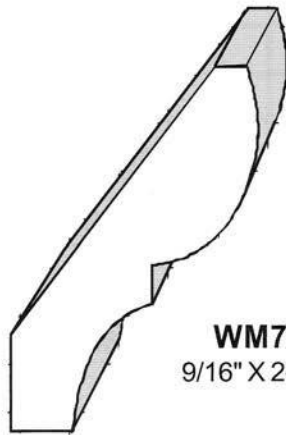

WM72
9/16" X 2-1/4"

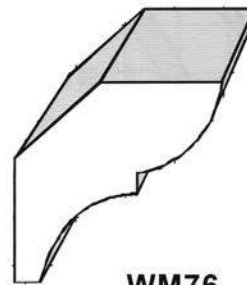

WM76
9/16" X 1-1/2"

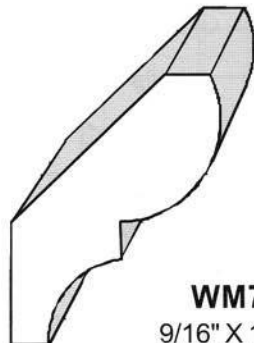

WM74
9/16" X 1-3/4"

COVE - Molding Patterns

Cove Molding has a distinctive concave profile. It is most often used at corners, to finishing edging materials, and as a ceiling cornice. A small dimension cove may be used as an inside corner guard.

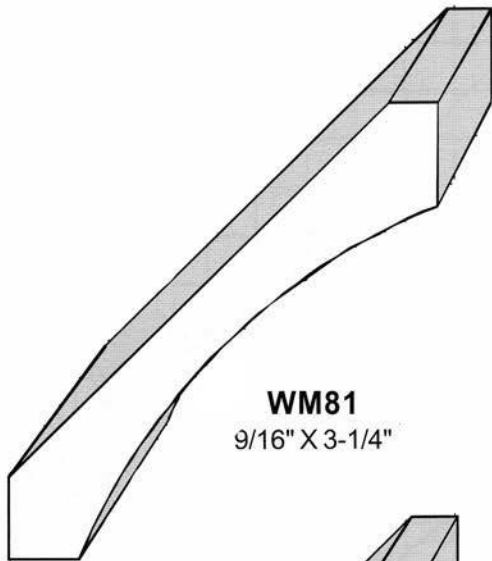

WM81
9/16" X 3-1/4"

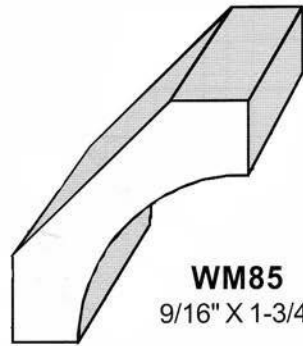

WM85
9/16" X 1-3/4"

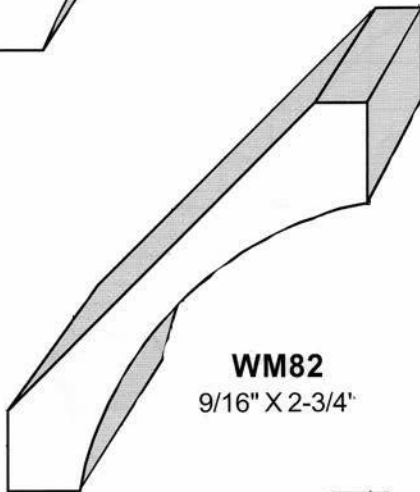

WM82
9/16" X 2-3/4"

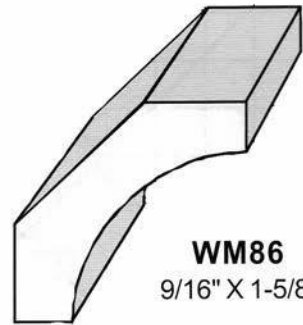

WM86
9/16" X 1-5/8"

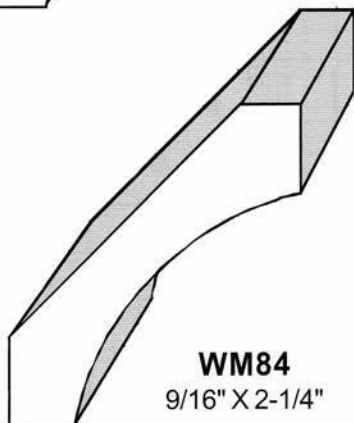

WM84
9/16" X 2-1/4"

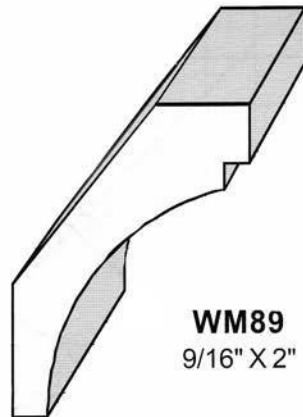

WM89
9/16" X 2"

Molding Patterns - COVE

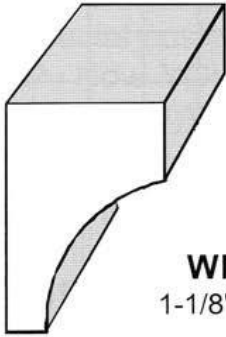

WM90
1-1/8" X 3/4"

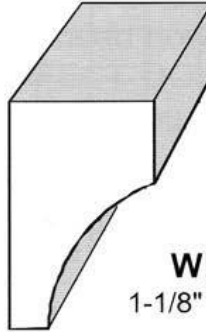

WM94
1-1/8" X 11/16"

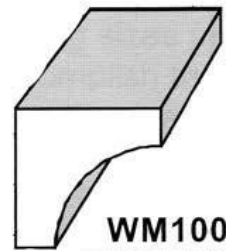

WM100
11/16" X 11/16"

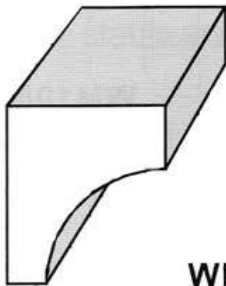

WM92
7/8" X 3/4"

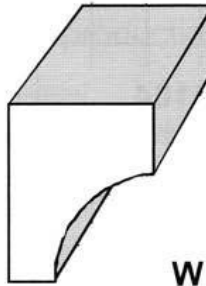

WM95
7/8" X 11/16"

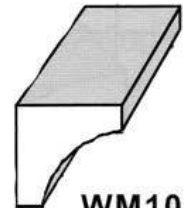

WM101
1/2" X 1/2"

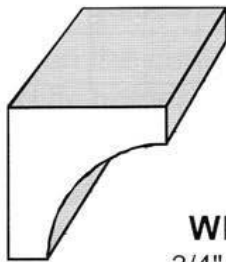

WM93
3/4" X 3/4"

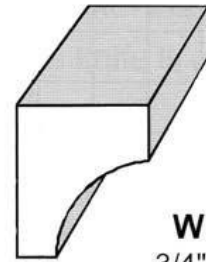

WM96
3/4" X 5/8"

QUARTER ROUND - Molding Patterns

Quarter Round is extremely versatile. It can be used as a base shoe, as an inside corner molding, or to cover any recessed, 90-degree juncture. It's frequently used to cover the line where soffit and siding meet on home exteriors.

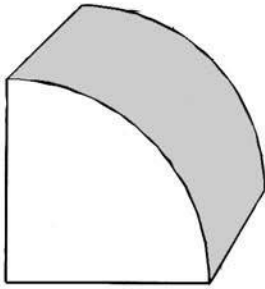

WM103
1-1/16" X 1-1/16"

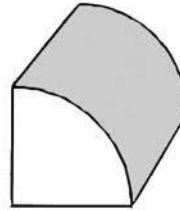

WM107
5/8" X 5/8"

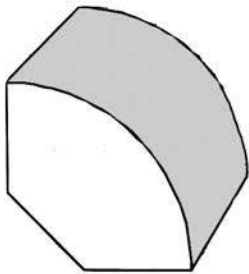

WM104
11/16" X 1-3/8"

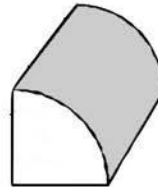

WM108
1/2" X 1/2"



WM105
3/4" X 3/4"



WM109
3/8" X 3/8"

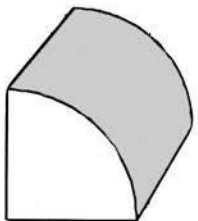

WM106
11/16" X 11/16"

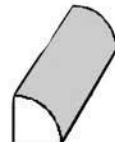

WM110
1/4" X 1/4"

Molding Patterns - HALF ROUND

Half Round Molding has the profile of half a circle. It can be used as a screen molding, bead, or panel mold. Applied to the facing edge of plywood shelving, it neatly hides the unsightly edge.

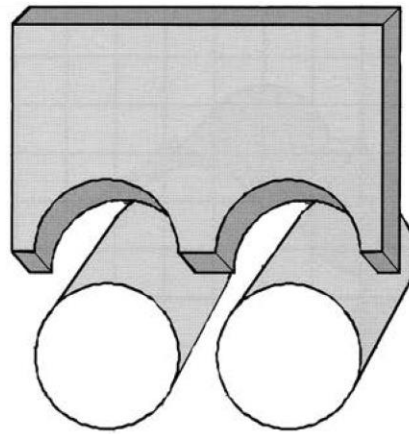

WM121 2-UP
3/4"

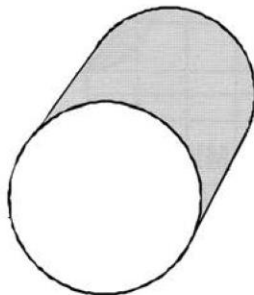
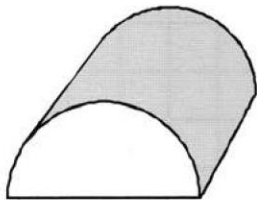

WM120
1"

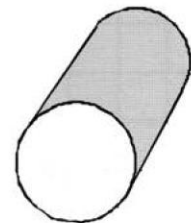
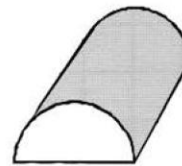

WM123
5/8"

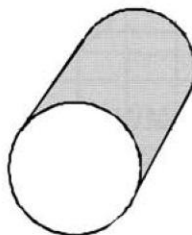
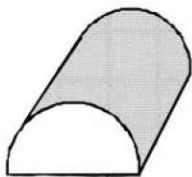

WM122
11/16"

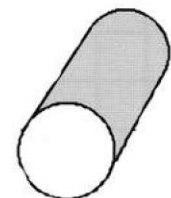
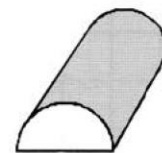

WM124
1/2"

BASE SHOE - Molding Patterns

Base Shoe is attached where the base molding meets the floor. This provides both molding and walls with extra protection against scuffs and damage from cleaning tools and hides floor unevenness.

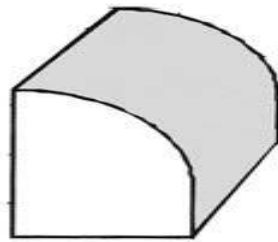

WM126
3/4" X 1/2"

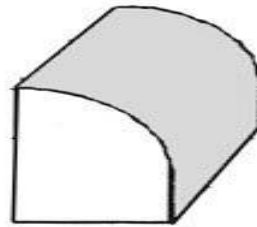

WM129
11/16" X 7/16"

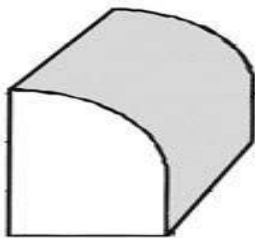

WM127
3/4" X 7/16"

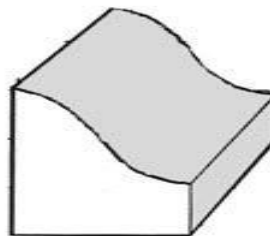

WM131
3/4" X 1/2"

Molding Patterns - ASTRAGAL

Astragal molding has a mirror-image profile. T-Astragal is attached to one of a set of doors to keep the doors from swinging through the opening. Flat Astragal is a decorative bead descended from classic Greek architectural design, a bead on a column just below its cap.

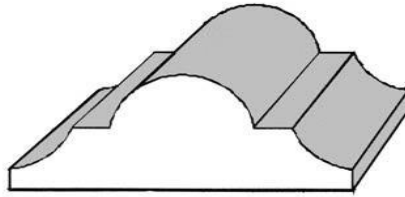

WM133
11/16" X 1-3/4"

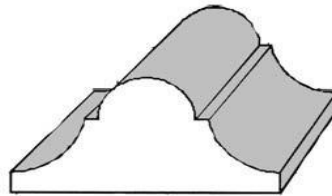

WM134
11/16" X 1-3/8"

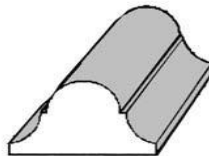

WM135
7/16" X 3/4"

SHELF EDGE / SCREEN - Molding Patterns

This pattern is the perfect way to cover the seam where pieces of porch screen meet, or where the screen is fastened to its frame. It's also a handy way to finish the facing edge of tabletops and shelving.

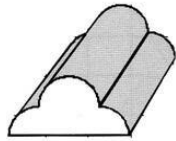

WM137
3/8" X 3/4"

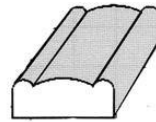

WM141
1/4" X 5/8"

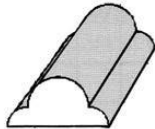

WM138
5/16" X 5/8"

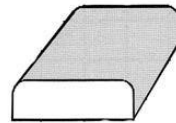

WM142
1/4" X 3/4"

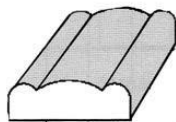

WM140
1/4" X 3/4"

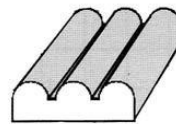

WM144
1/4" X 3/4"

Molding Patterns - GLASS BEAD

A glass bead is used to hold the glazing in place in windows. It's also known as glass stop, cove and bead, putty bead, glazing bead, and staff bead.

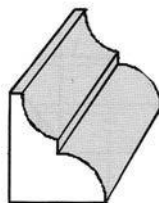

WM147
9/16" X 1/2"

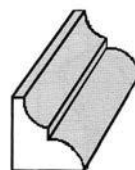

WM148
3/8" X 3/8"

BASE CAP - Molding Patterns

Base Caps are applied at the top of base moldings as a decorative transition between moldings and the wall. They are also useful as panel moldings.

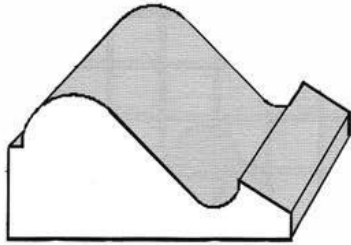

WM163
11/16" X 1-3/8"

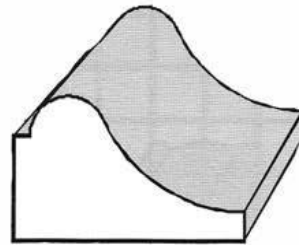

WM167
11/16" X 1-1/8"

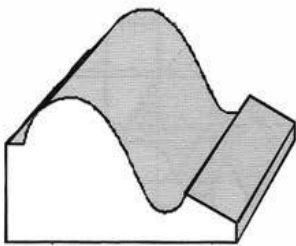

WM164
11/16" X 1-1/8"

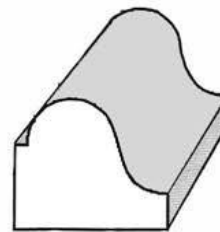

WM172
5/8" X 3/4"

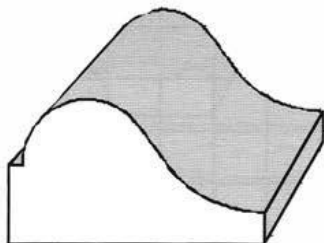

WM166
11/16" X 1-1/4"

SHINGLE AND PANEL - Molding Patterns

These patterns can be used to create panel molding (see "panel molding knives") or as shingle molding applied to a building's rake and around exterior window frames.

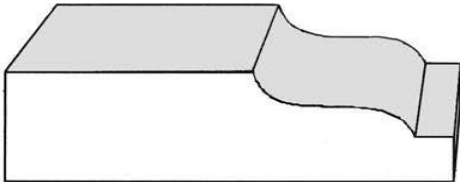

WM207
11/16" X 2-1/2"

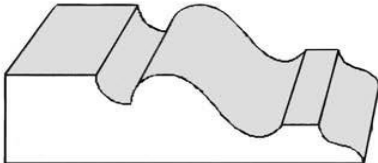

WM213
9/16" X 2"

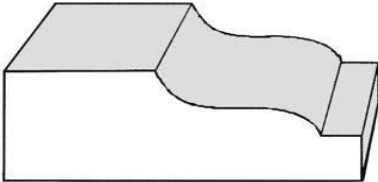

WM209
11/16" X 2"

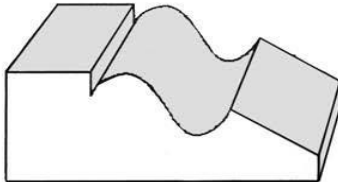

WM217
11/16" X 1-3/4"

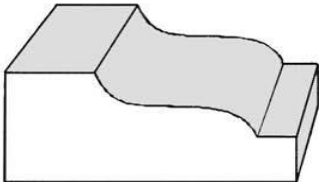

WM210
11/16" X 1-5/8"

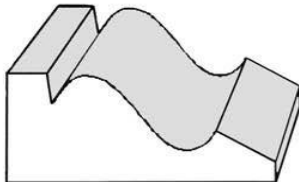

WM218
11/16" X 1-1/2"

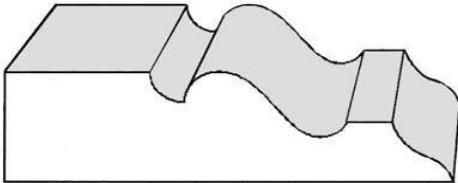

WM212
11/16" X 2-1/2"

Molding Patterns - BATTEN

Batten trim is a thin strip, used to cover seams between panels of interior paneling or exterior siding.

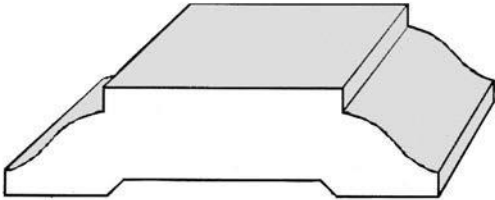

WM224
9/16" X 2-1/4"

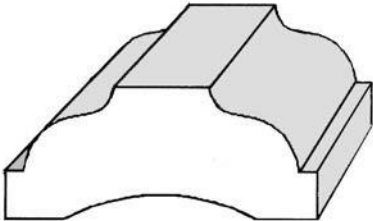

WM229
11/16" X 1-5/8"

HANDRAIL - Molding Patterns

These patterns are in high demand for custom homes, especially in species such as walnut and mahogany.

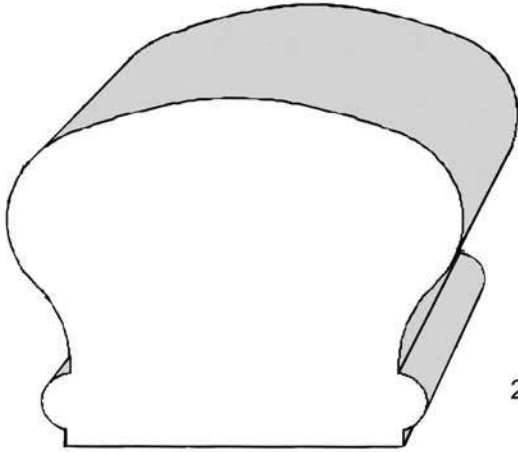

WM1000
2-3/8" X 1-13/16"

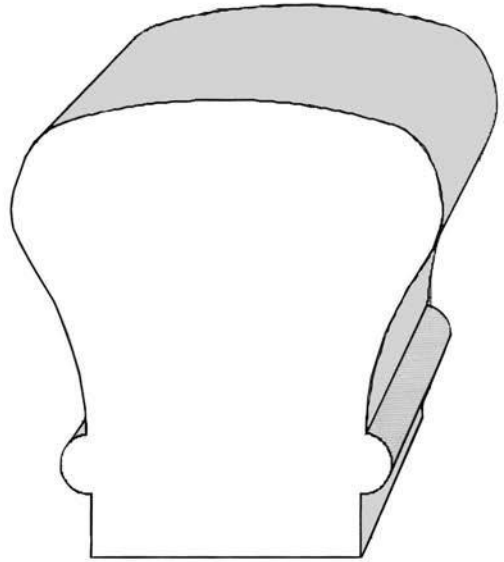

WM1003
2-1/4" X 2-3/8"

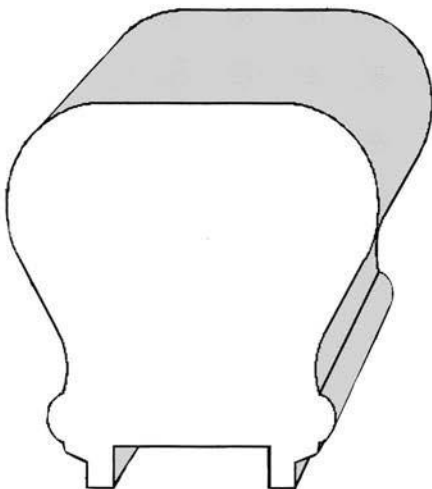

WM1001
1-15/16" X 2"

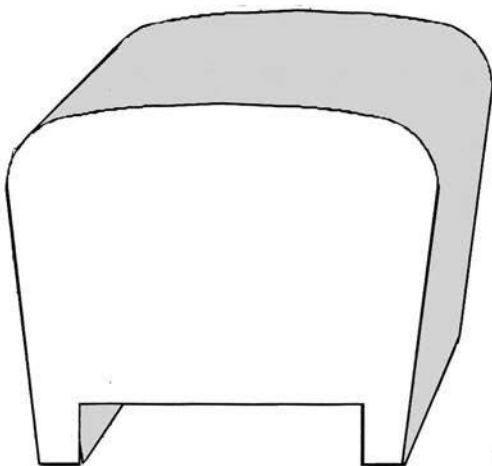

WM1002
2-1/4" X 1-7/8"

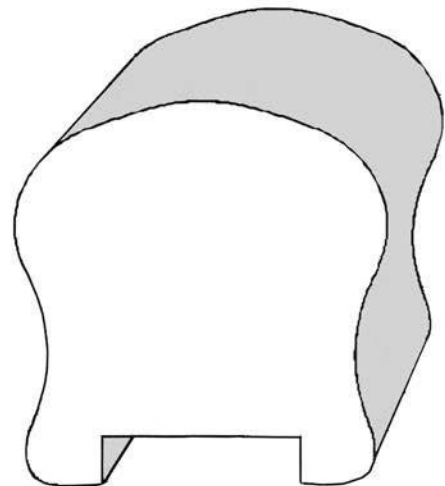

WM1004
1-15/16" X 2"

Molding Patterns - PICTURE

Picture mold is a type of crown molding. It mounts high on the wall and lets you hang pictures or mirrors anywhere you like without putting hooks on your walls. Place hooks over the top of the molding, then hang the picture from wires.

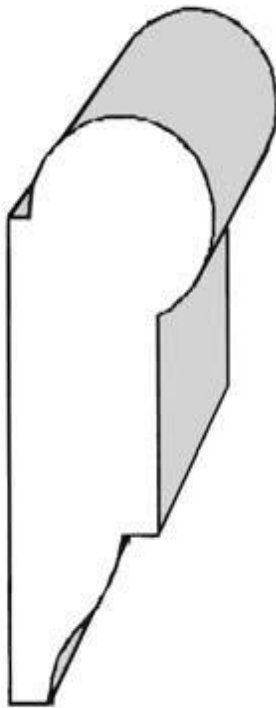

WM273
11/16" X 1-3/4"

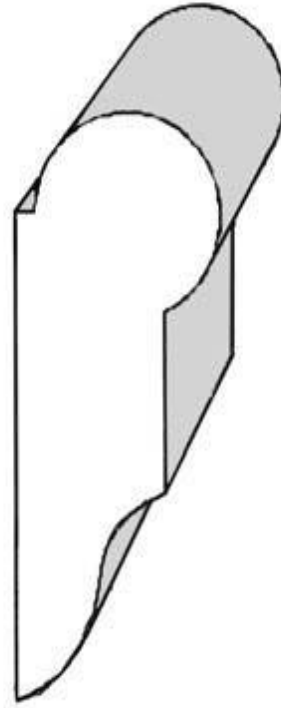

WM276
11/16" X 1-3/4"

WAINSCOT/PLYCAP - Molding Patterns

Wainscot / Plycap Moldings are used to finish the exposed end grain of wainscoting or sheets of plywood.

It places a handsome cap across the visible edge. Sometimes called a dado cap or wainscot molding.

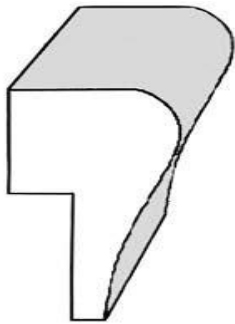

WM290
11/16" X 1-3/8"

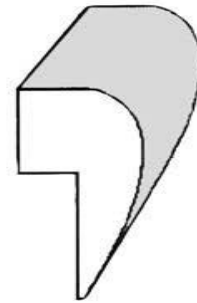

WM295
1/2" X 1-1/4"

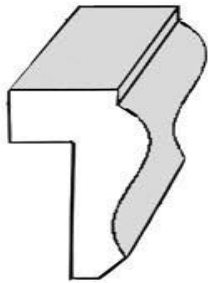

WM292
9/16" X 1-1/8"

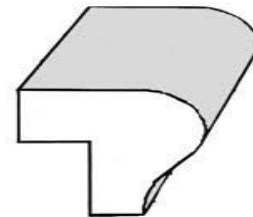

WM296
3/4" X 3/4"

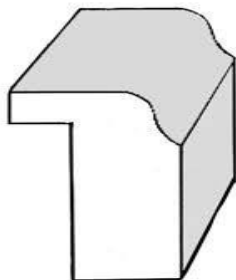

WM294
11/16" X 1-1/8"

Molding Patterns - CHAIR RAIL

Chair rail is an interior molding intended to keep chairs from backing into and damaging the walls. It's applied parallel to base molding all around the room's perimeter.

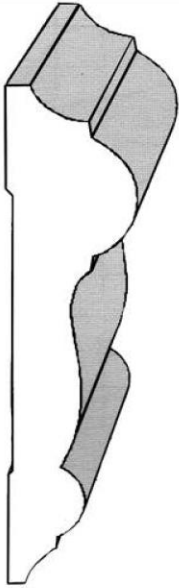

WM297
11/16" X 3"

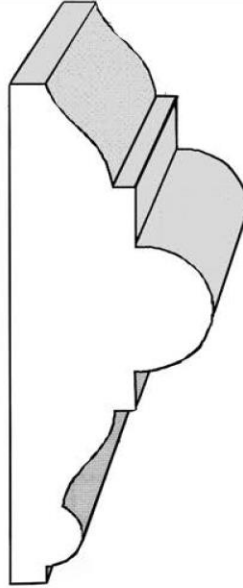

WM300
1-1/16" X 3"



WM304
1/2" X 2-1/4"

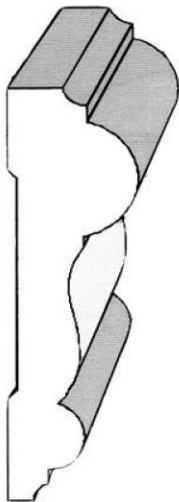

WM298
11/16" X 2-1/2"



WM303
9/16" X 2-1/2"

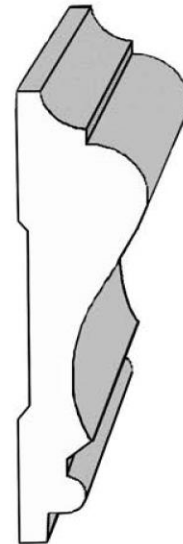

WM390
11/16" X 2-5/8"

Molding Patterns - CASING

Casing patterns are used to trim the inside and outside of door and window openings and may be as simple or elaborate as you like. Casing styles include Colonial, Victorian, Georgian, fluted, reeded, and ranch.

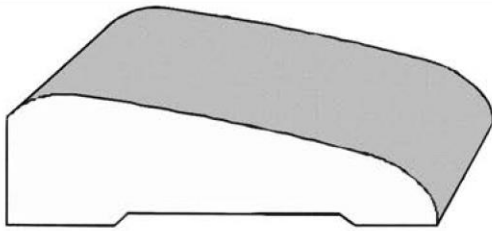

WM306
11/16" X 2-1/4"

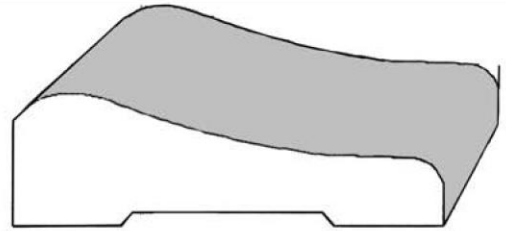

WM321
11/16" X 2-1/4"

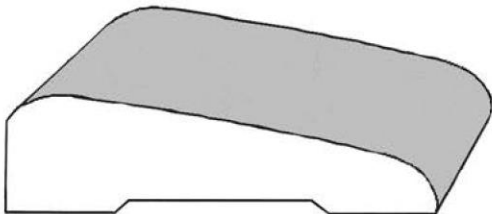

WM307
5/8" X 2-1/4"

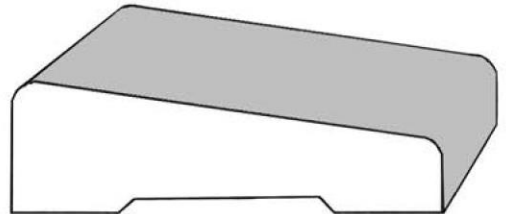

WM324
11/16" X 2-1/4"

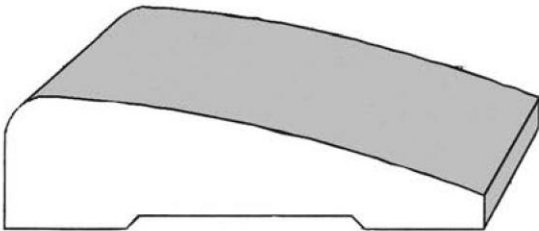

WM315
11/16" X 2-1/2"

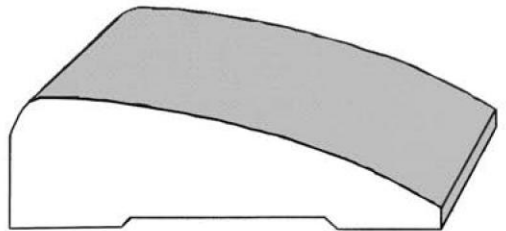

WM327
11/16" X 2-1/4"

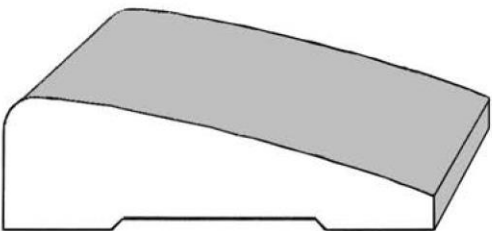

WM316
11/16" X 2-1/4"

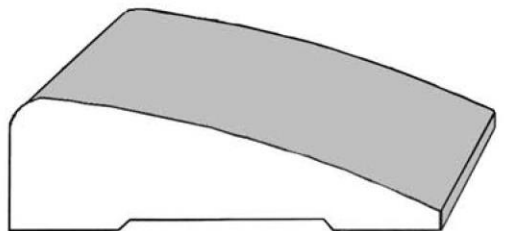

WM328
11/16" X 2-1/4"

CASING - Molding Patterns

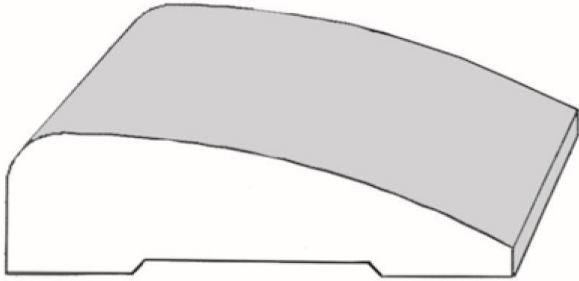

WM329
11/16" X 2-1/4"

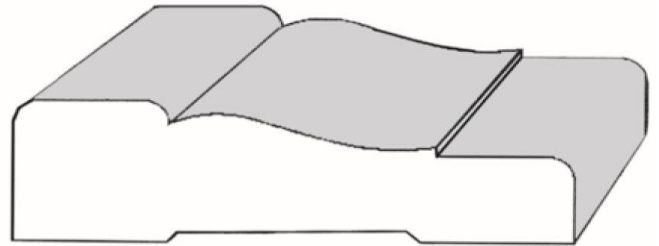

WM351
11/16" X 2-1/2"

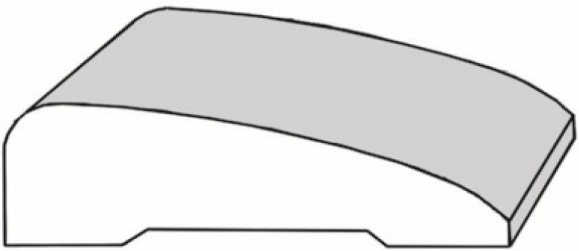

WM330
11/16" X 2-1/4"

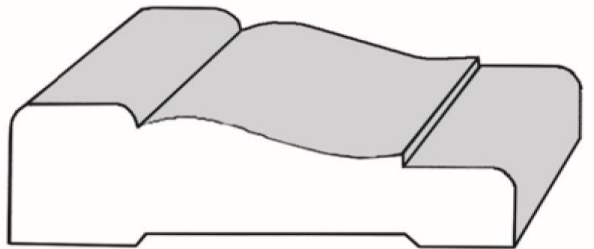

WM356
11/16" X 2-1/4"

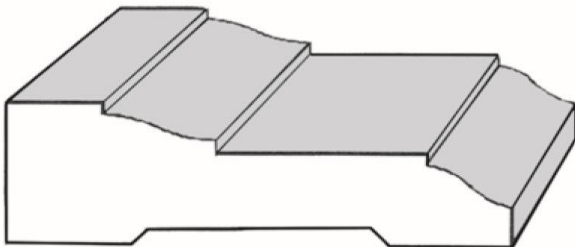

WM332
11/16" X 2-1/4"

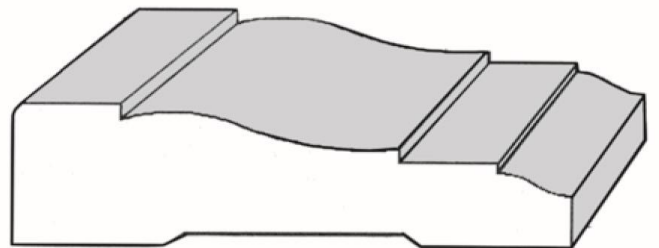

WM361
11/16" X 2-1/2"

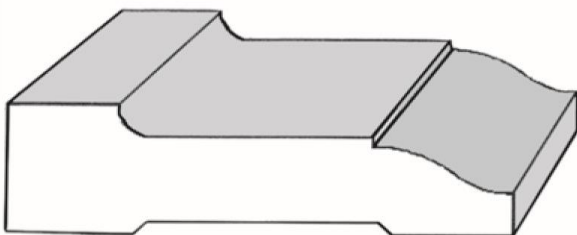

WM346
5/8" X 2-1/4"

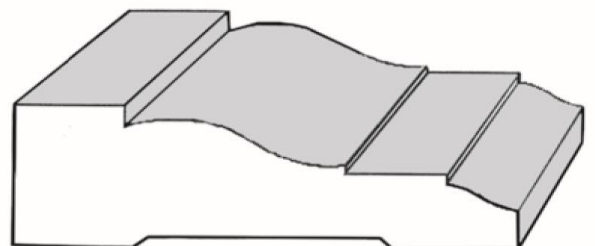

WM366
11/16" X 2-1/4"

Molding Patterns - CASING

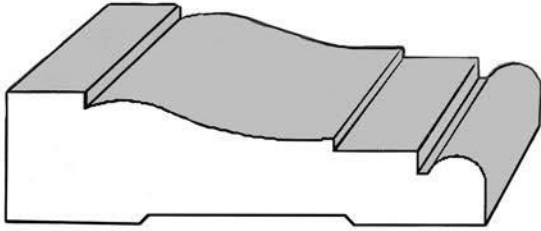

WM371
11/16" X 2-1/2"

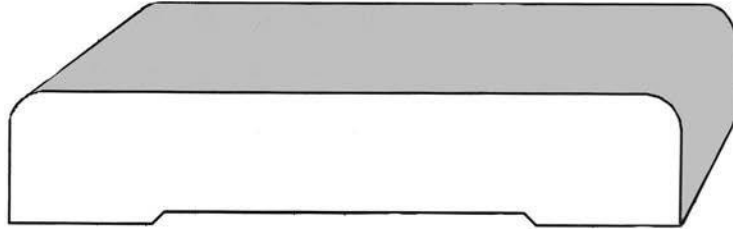

WM412
11/16" X 3-1/2"

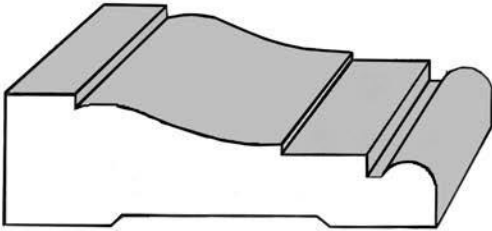

WM376
11/16" X 2-1/4"

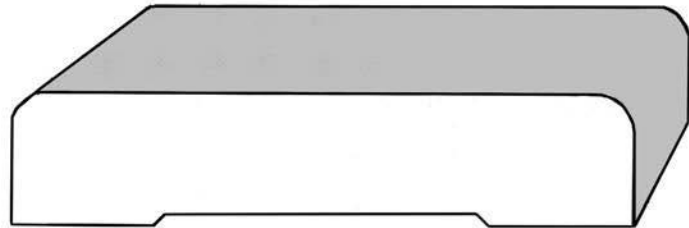

WM413
11/16" X 3-1/4"

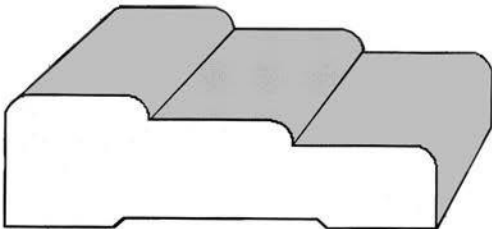

WM387
11/16" X 2-1/4"

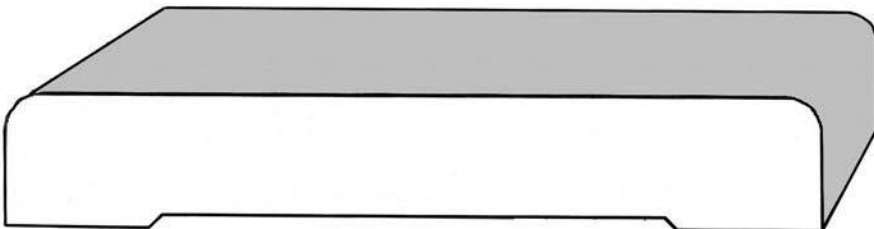

WM410
11/16" X 4-1/4"

CASING - Molding Patterns

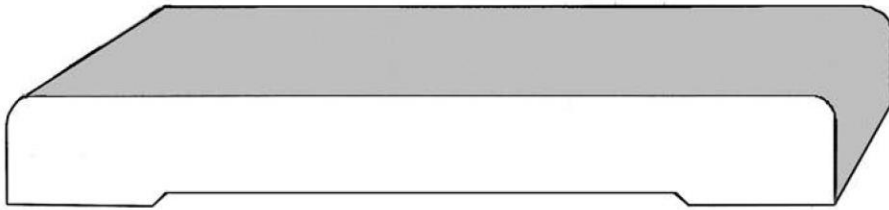

WM430
9/16" X 4-1/4"

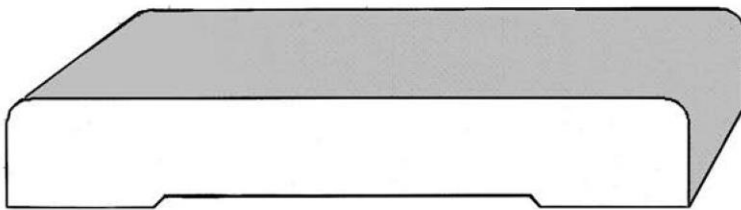

WM432
9/16" X 3-1/2"

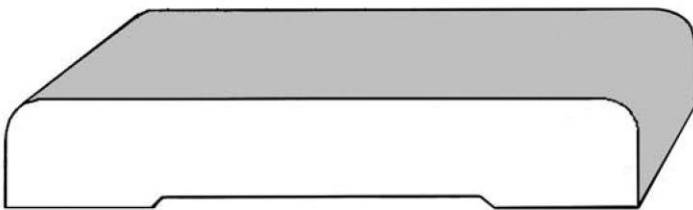

WM433
9/16" X 3-1/4"

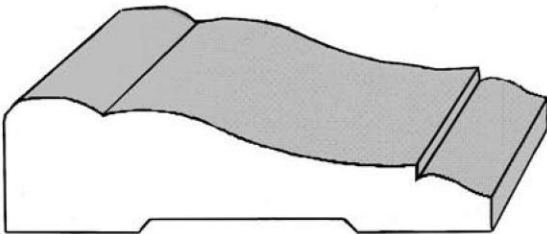

WM440
11/16" X 2-1/2"

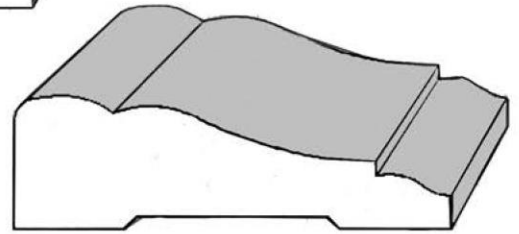

WM442
11/16" X 2-1/4"

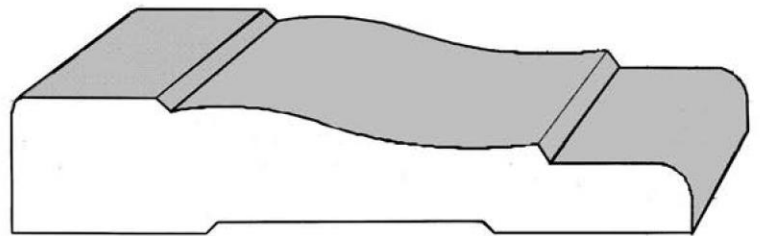

WM444
11/16" X 3-1/2"

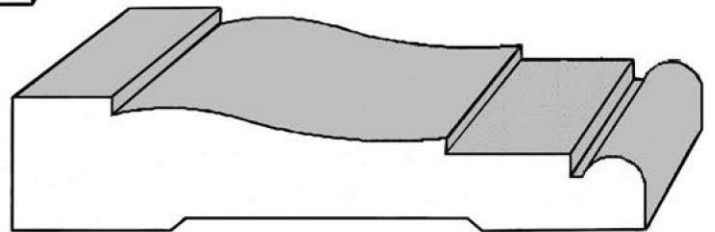

WM445
11/16" X 3-1/4"

Molding Patterns - CASING

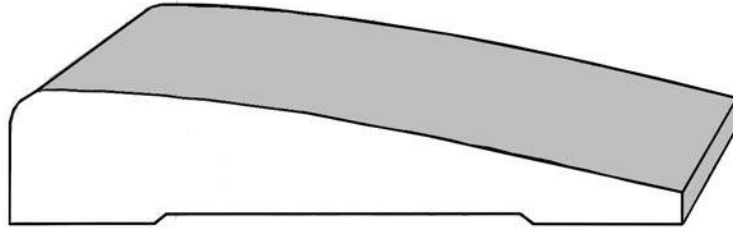

WM448
11/16" X 3-1/2"

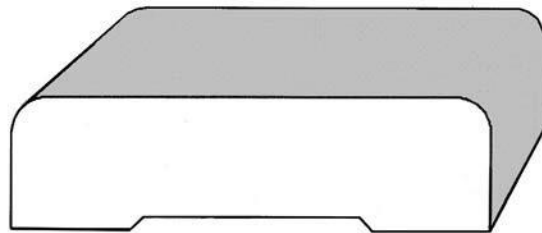

WM452
11/16" X 2-1/2"

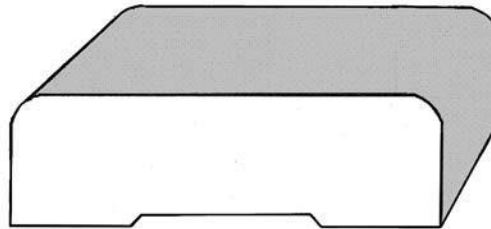

WM453
11/16" X 2-1/4"

CASING - Molding Patterns

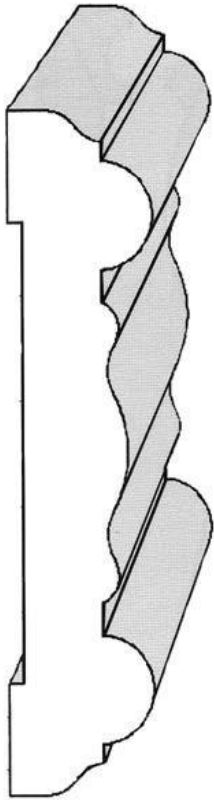

A41
3/4" X 3-1/4"



A42
3/4" X 4-1/4"



A43
3/4" X 4-1/4"

Molding Patterns - CASING

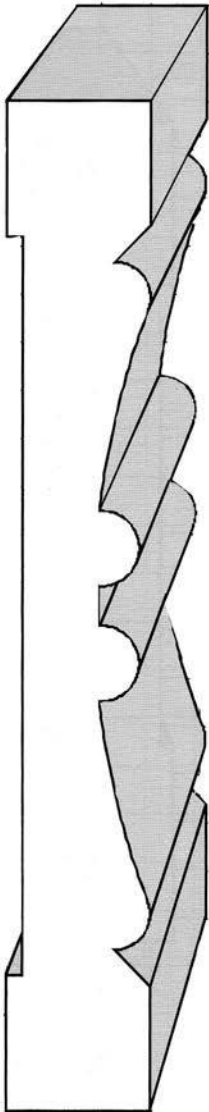

A44
3/4" X 5-1/4"

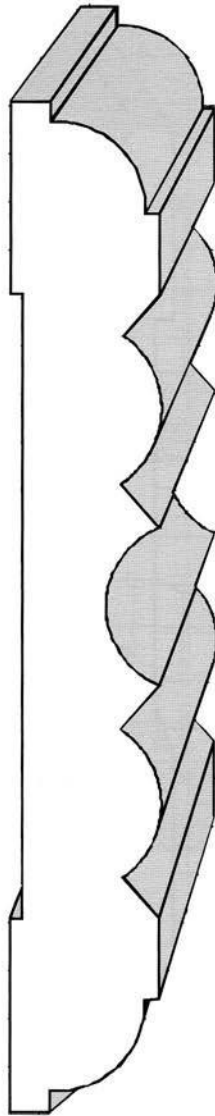

A45
3/4" X 5-1/4"

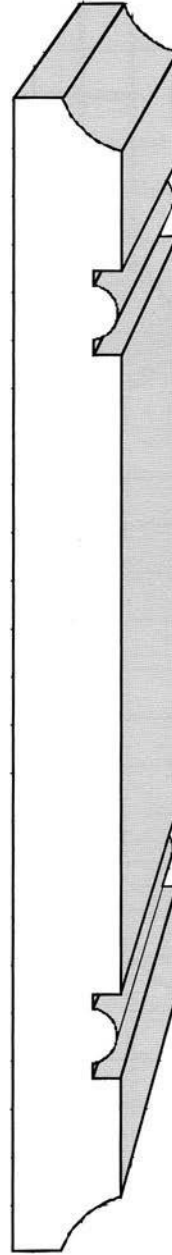

A46
9/16" X 6"

CASING - Molding Patterns

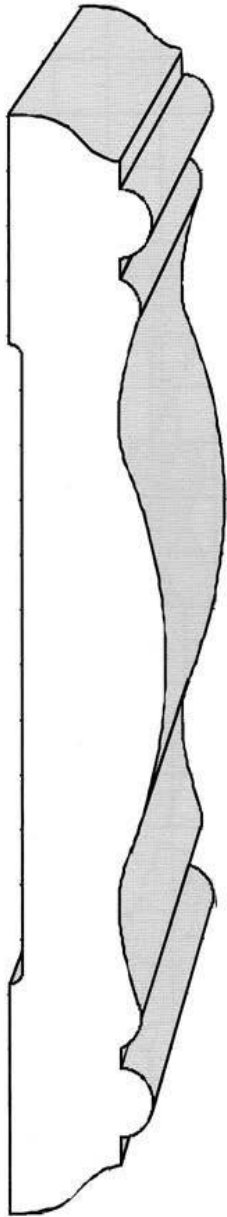

WM2000
3/4" X 5"

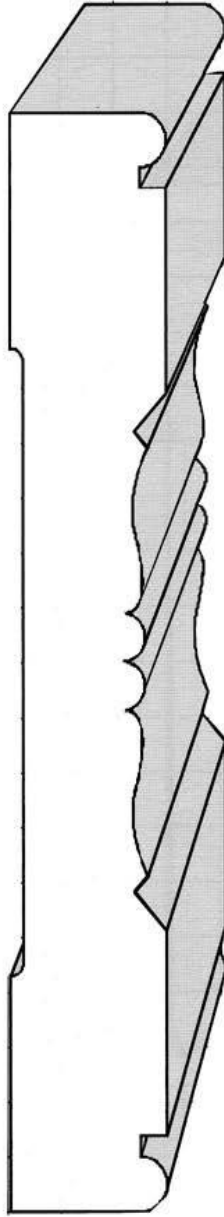

WM2001
3/4" X 5"

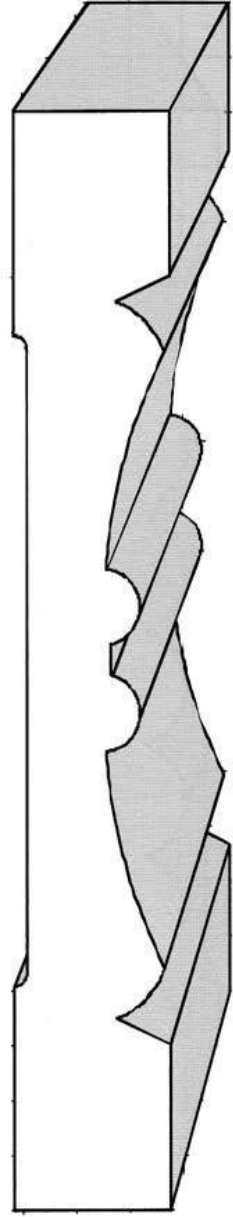

WM2002
3/4" X 5"

Molding Patterns - CASING

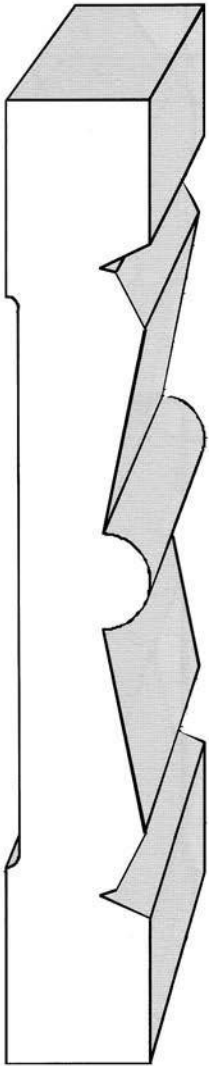

WM2003
3/4" X 5"

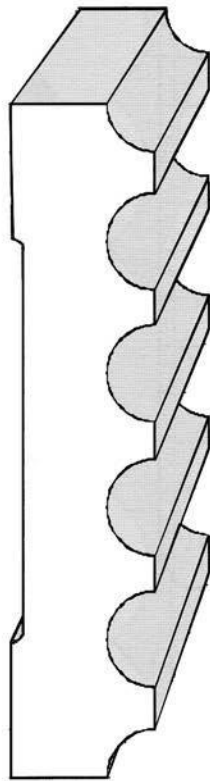

WM2004
3/4" X 3-1/2"



WM2005
1/2" X 2-3/4"

CASING - Molding Patterns

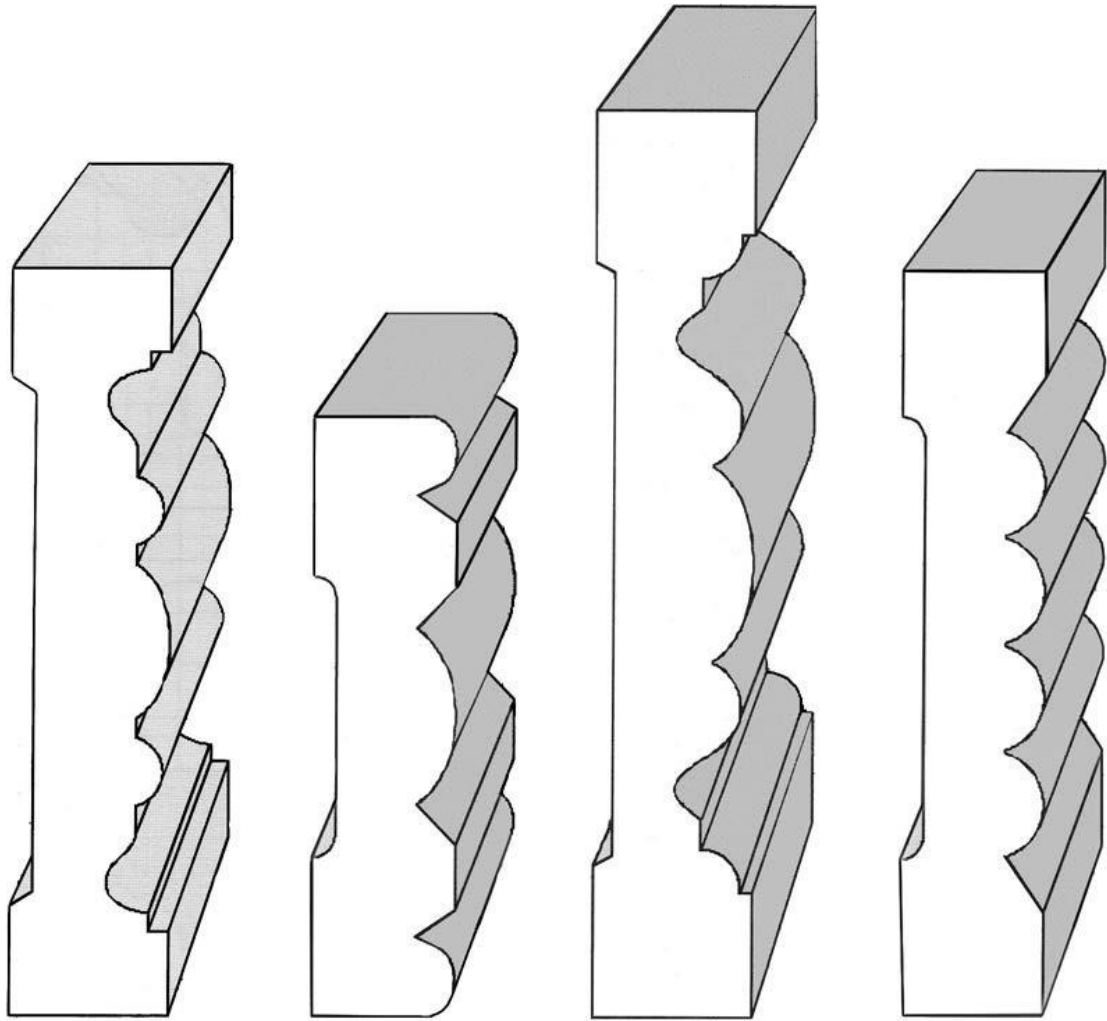

WM2006
3/4" X 3-1/2"

WM2007
11/16" X 2-13/16"

WM2008
3/4" X 4-1/4"

WM2009
11/16" X 3-1/2"

CASING - Molding Patterns

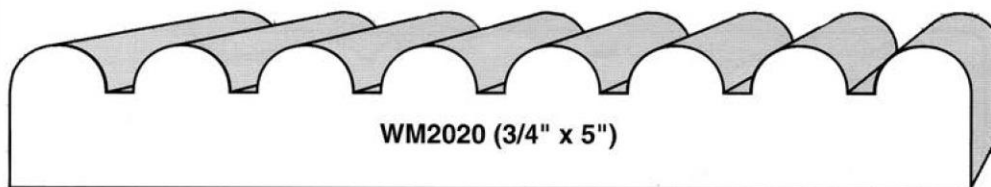
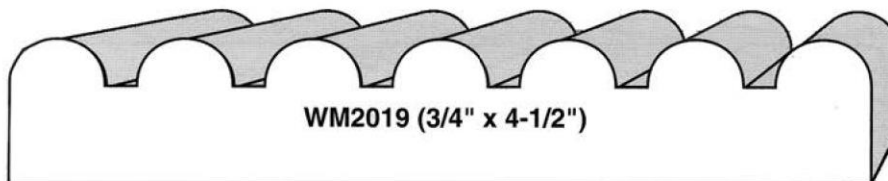
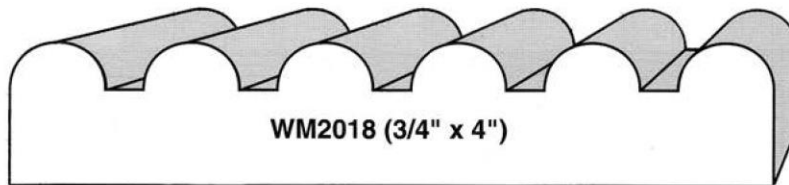
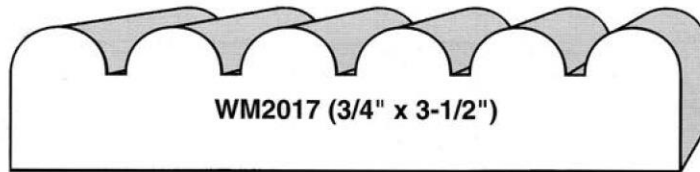
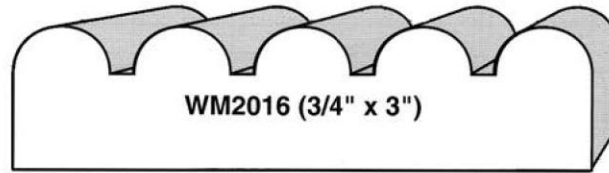
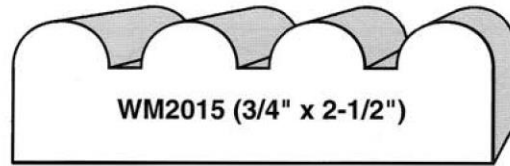

CASING - Molding Patterns

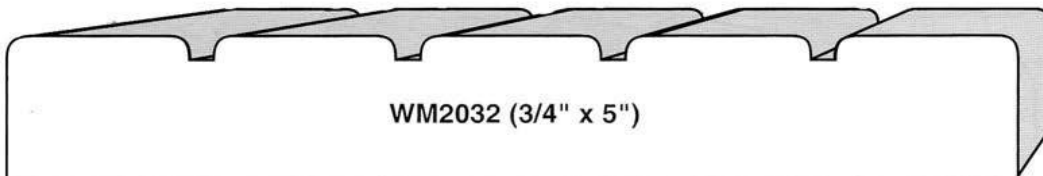
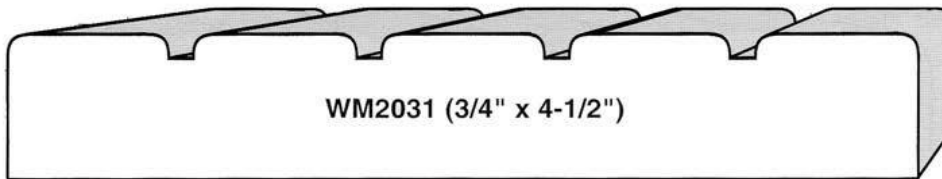
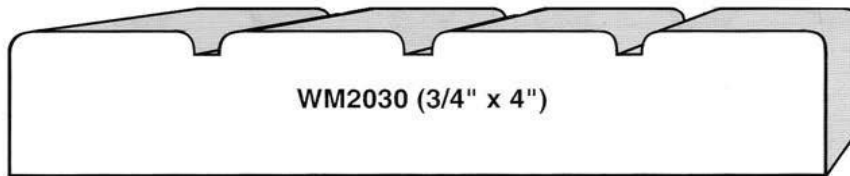
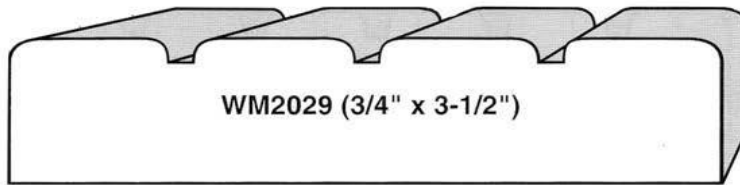
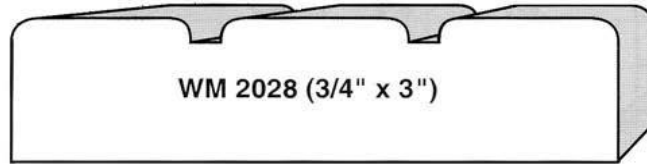
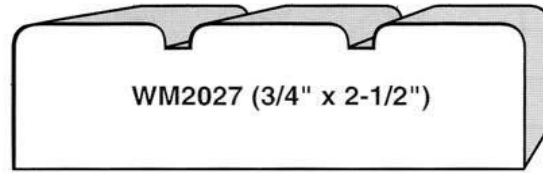

Molding Patterns - CASING

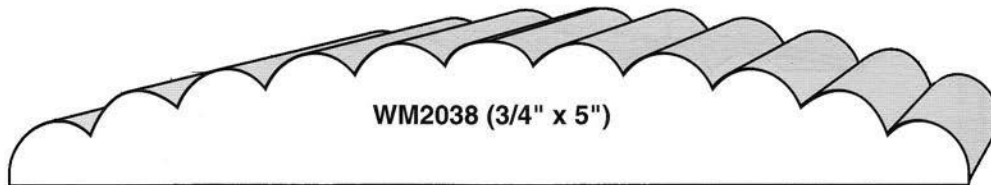
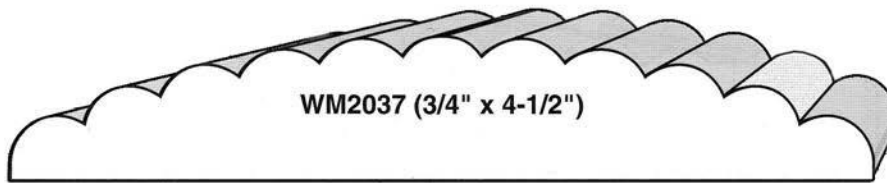
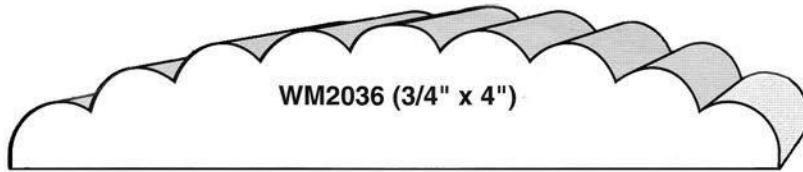
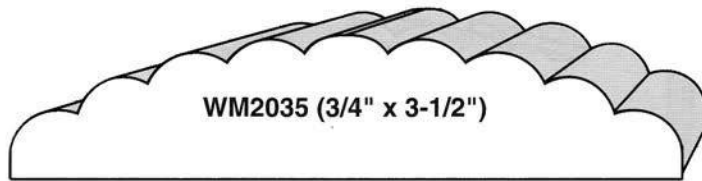
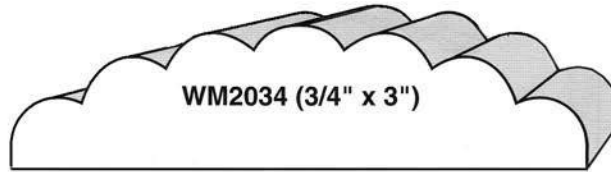
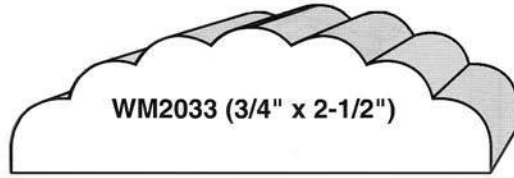

CASING - Molding Patterns

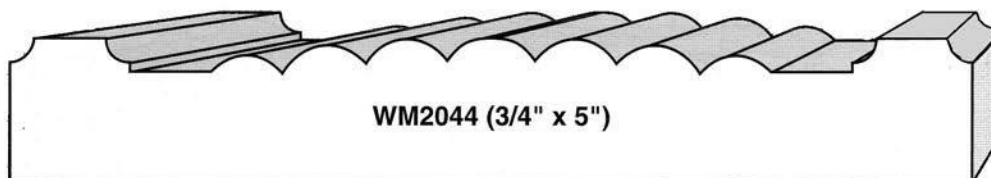
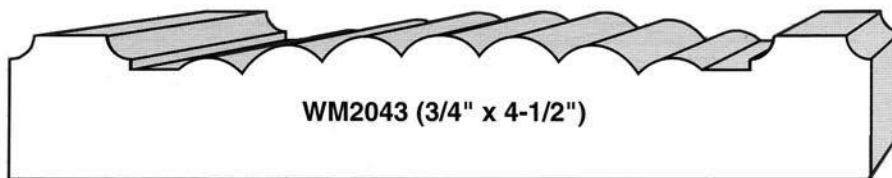
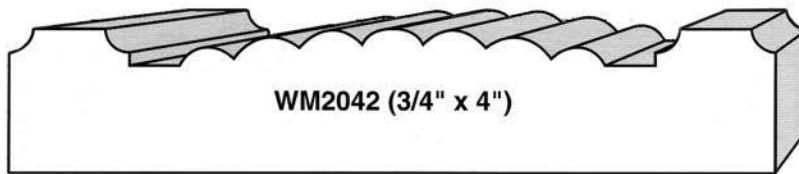
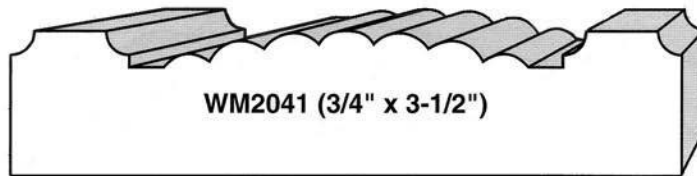
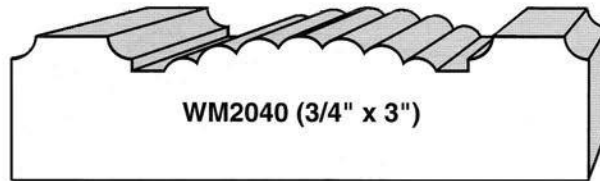
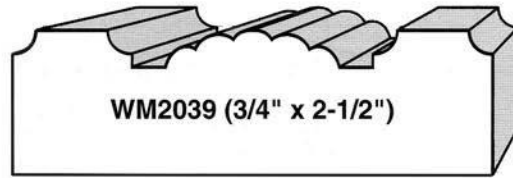

Molding Patterns - CASING

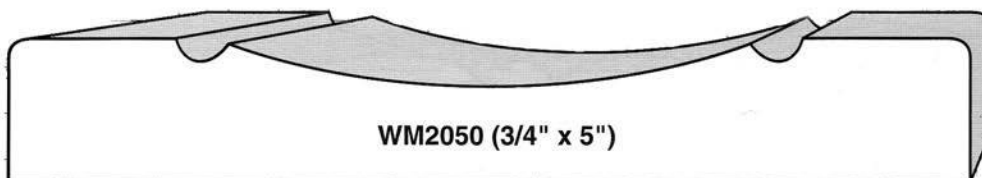
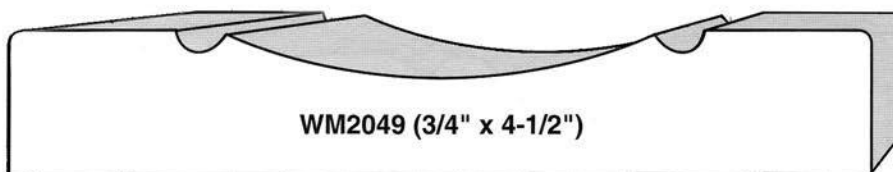
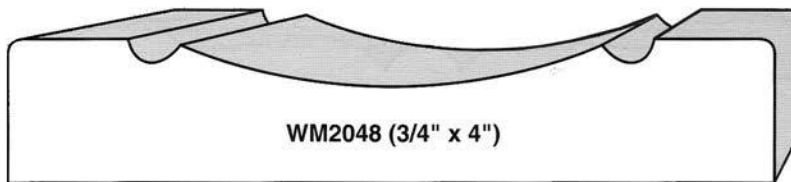
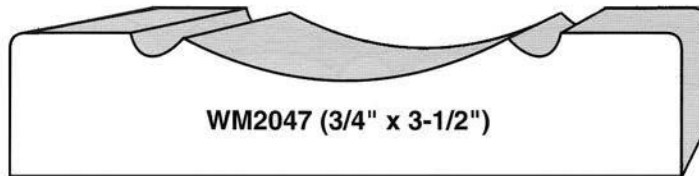
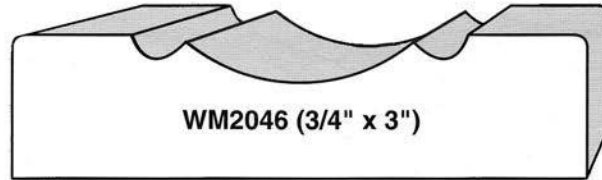
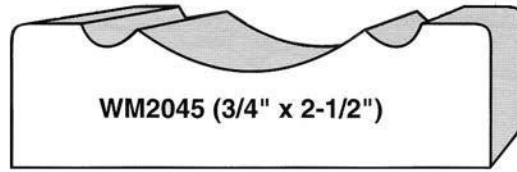

CASING - Molding Patterns

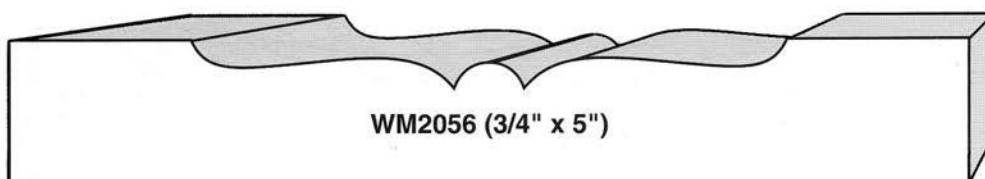
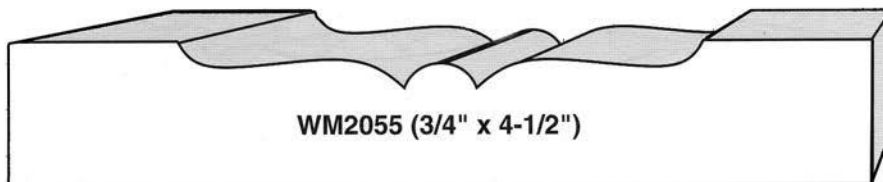
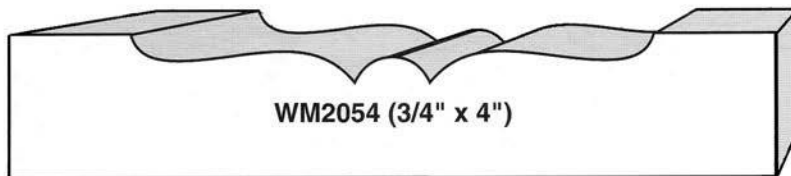
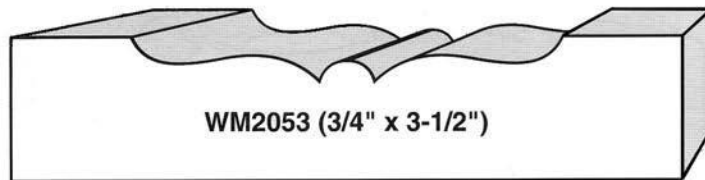
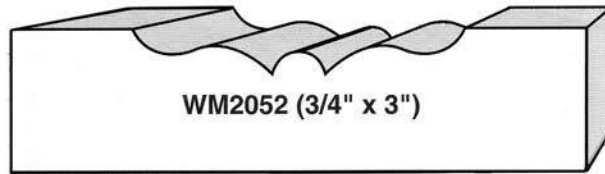
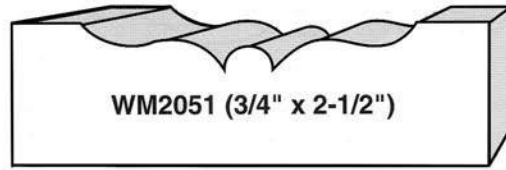

Molding Patterns - CASING

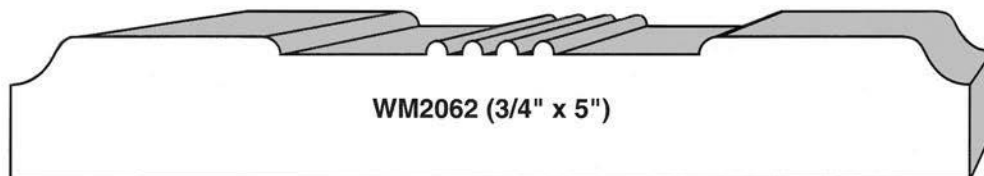
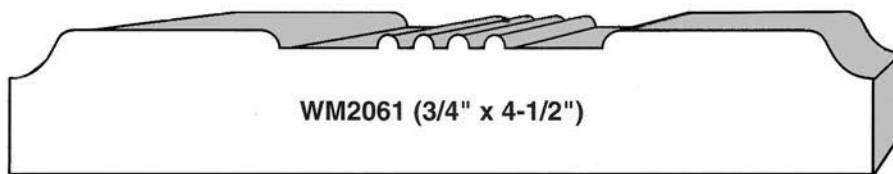
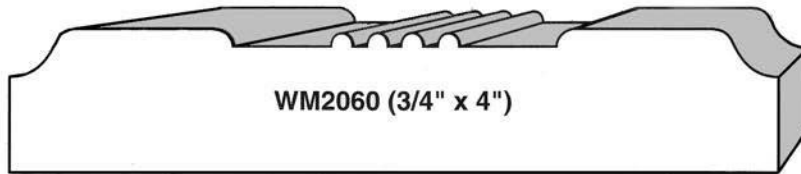
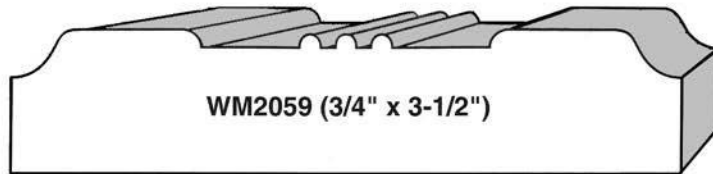
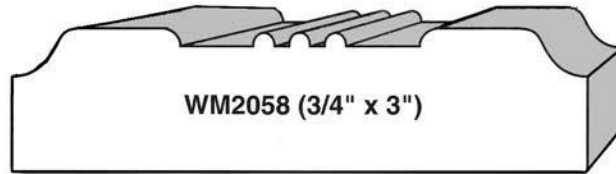
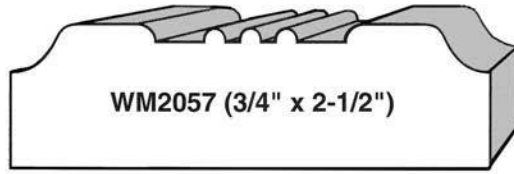

CASING - Molding Patterns

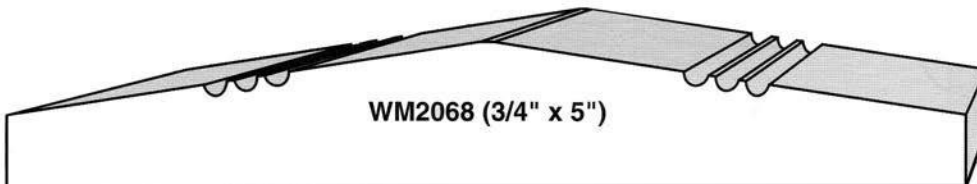
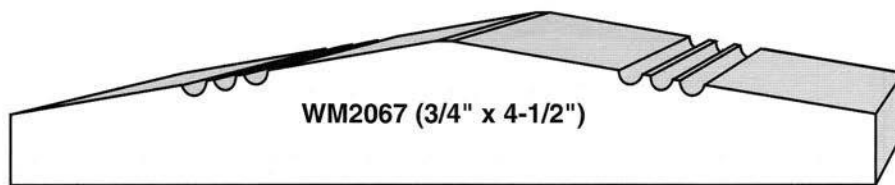
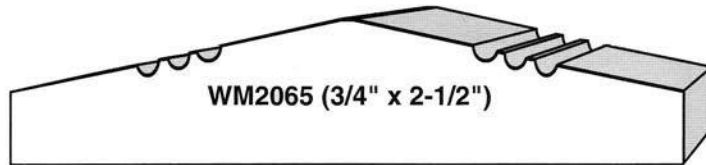
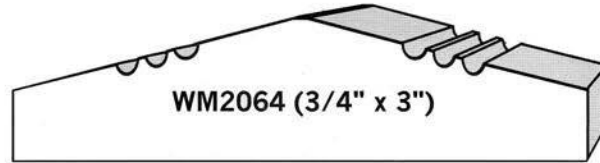
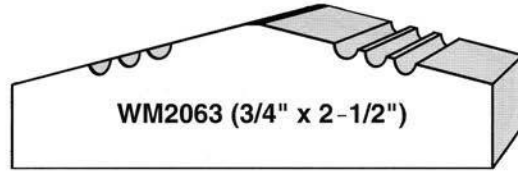

Molding Patterns - CASING

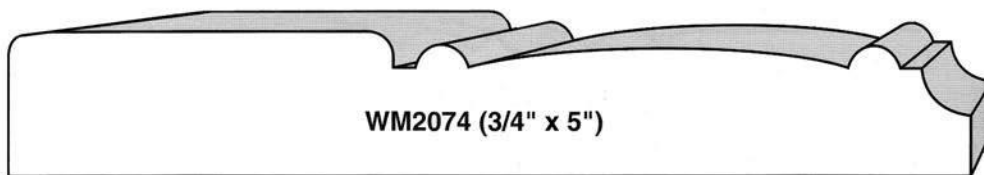
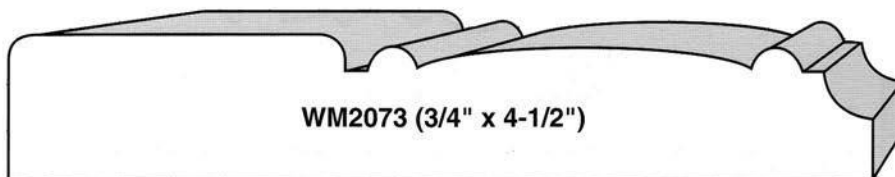
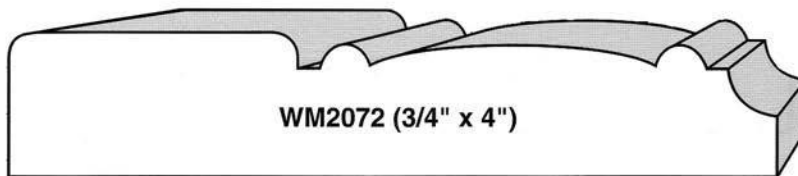
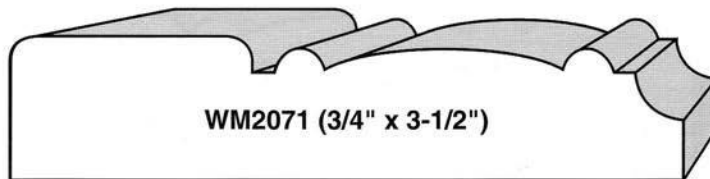
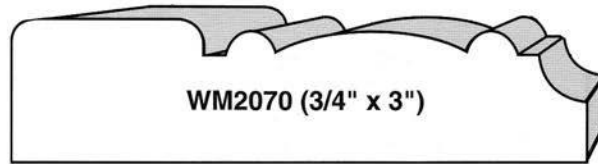
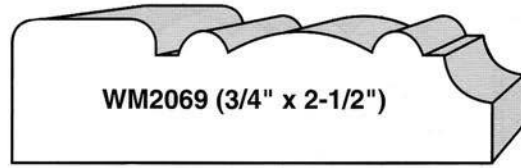

CASING - Molding Patterns

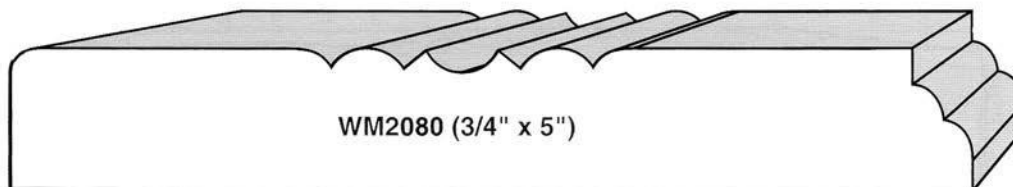
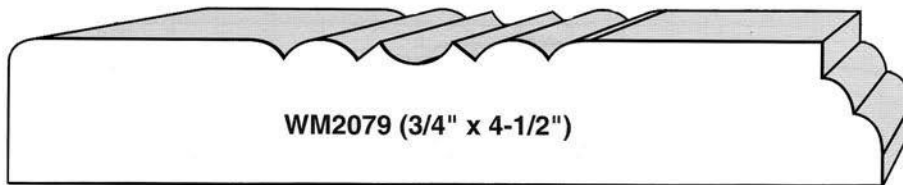
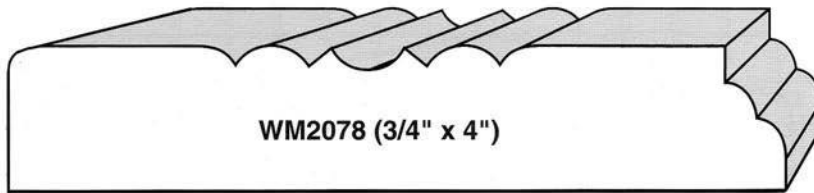
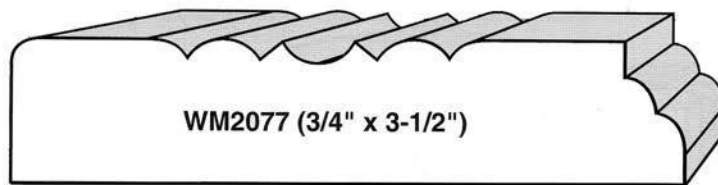
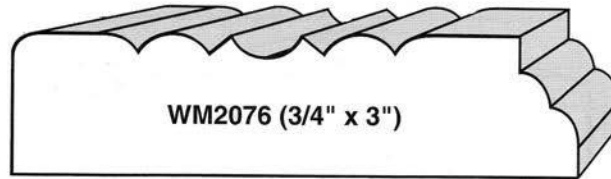
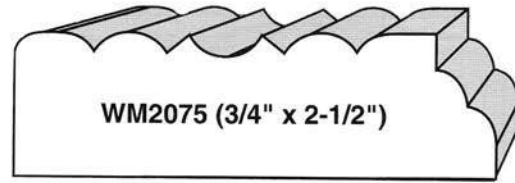

Molding Patterns - CASING

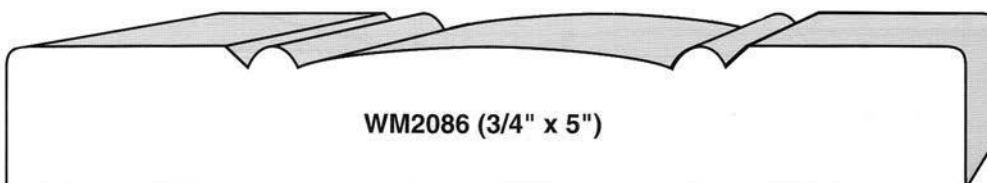
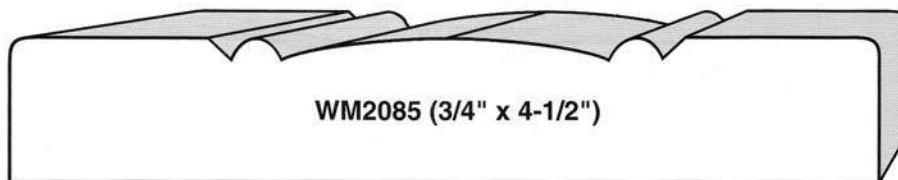
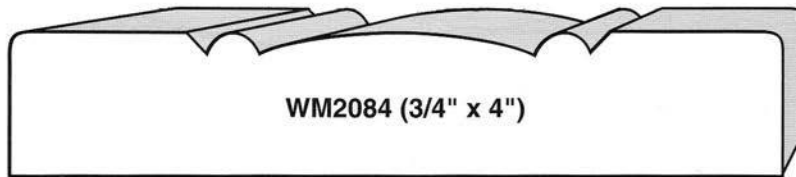
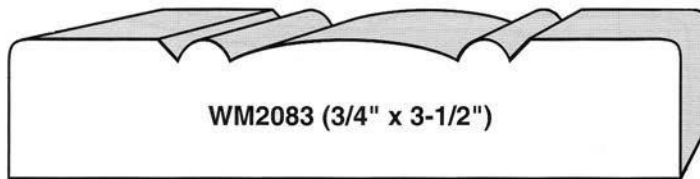
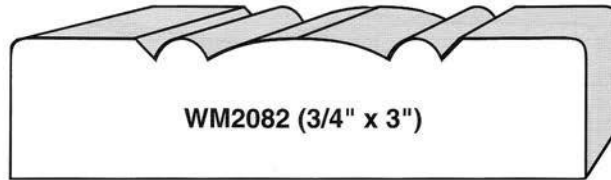
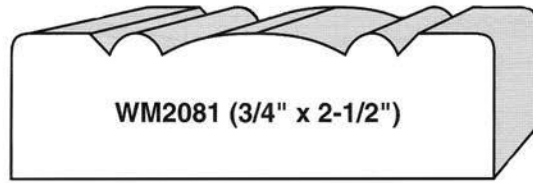

CASING - Molding Patterns

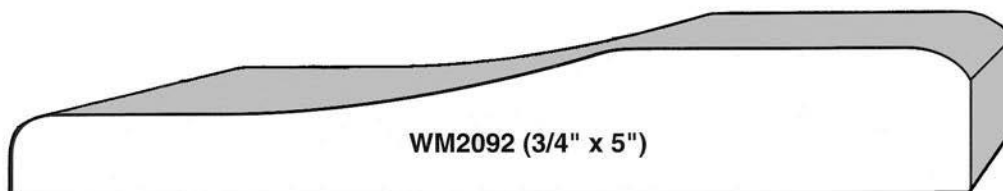
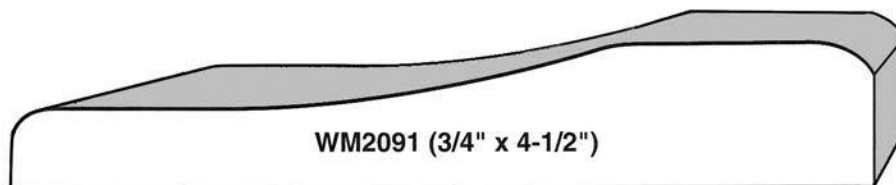
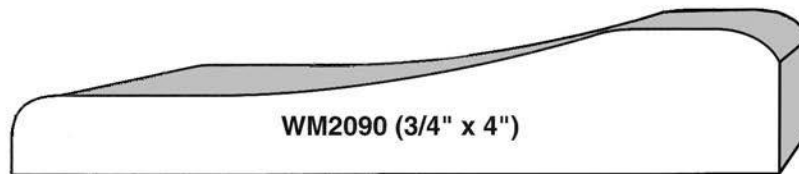
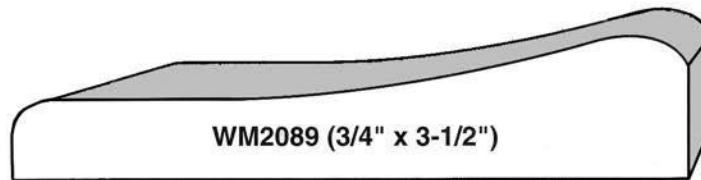
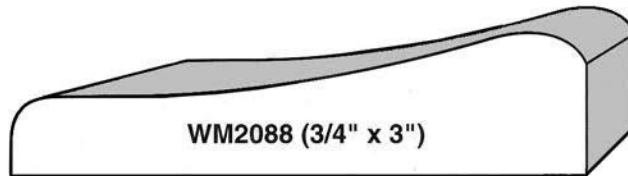
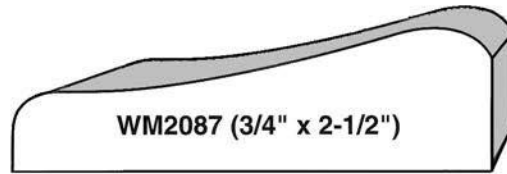

Molding Patterns - CASING

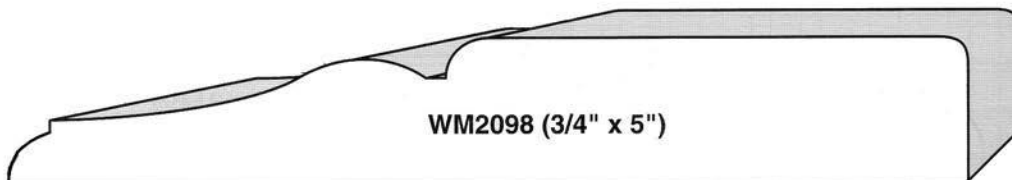
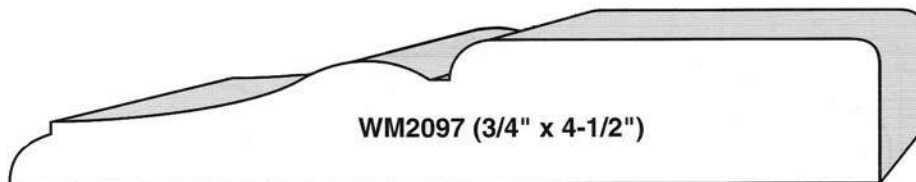
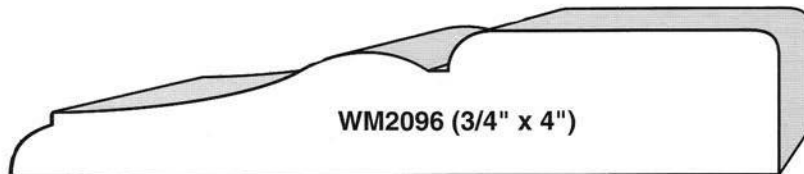
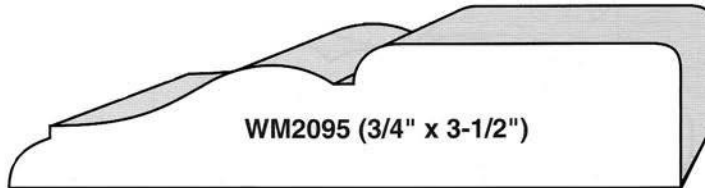
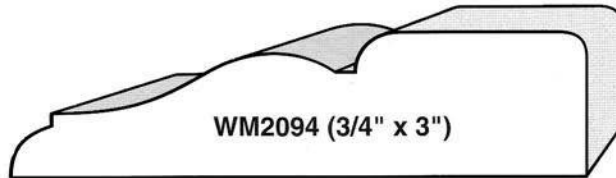
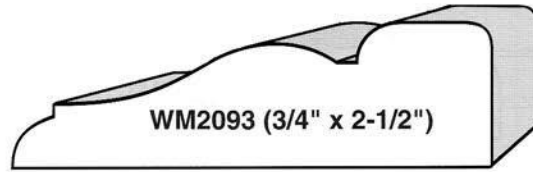

CASING - Molding Patterns

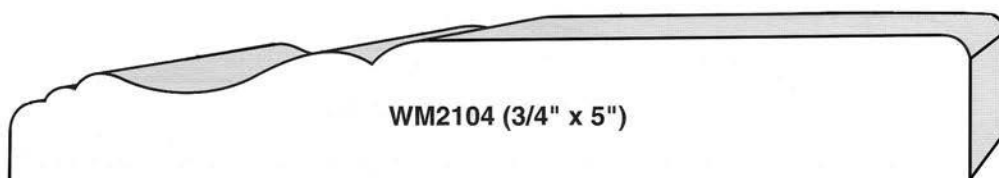
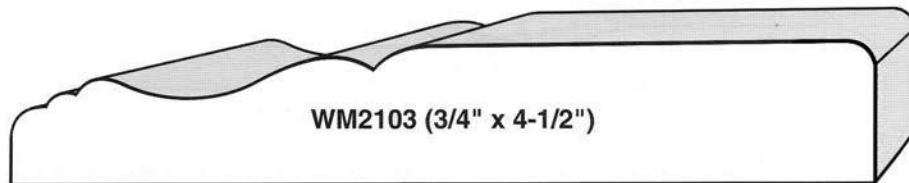
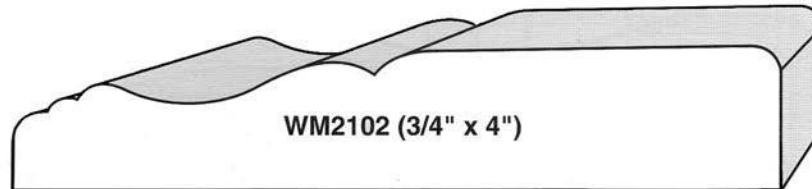
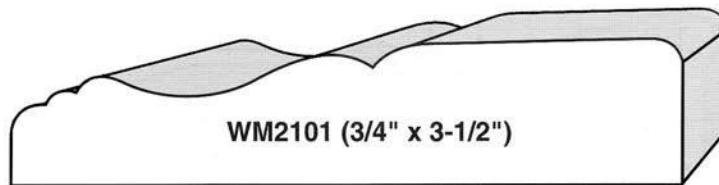
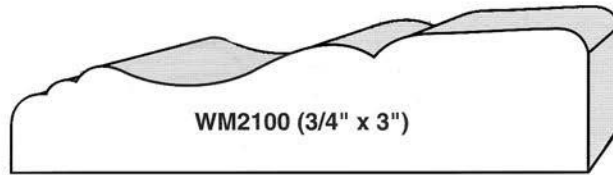
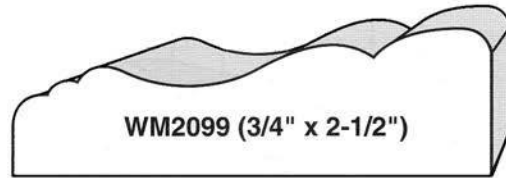

Molding Patterns - COLONIAL CASING

Colonial Casing Patterns are typically more intricate and wider than modern, ranch-style patterns. They are often used to surround large, wide openings.

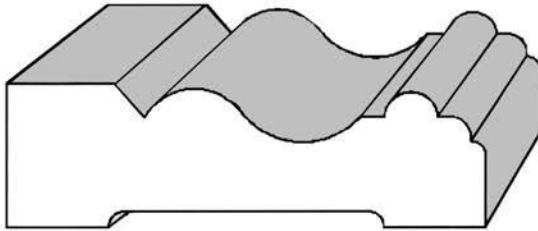

WM501
2-1/2" x 3/4"

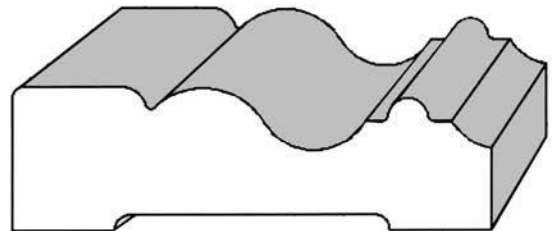

WM504
2-1/2" x 3/4"

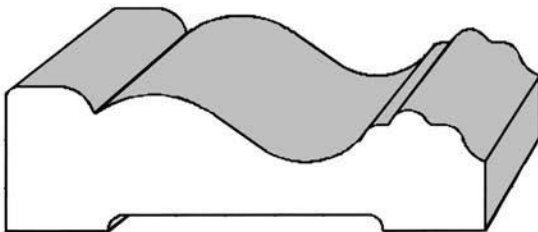

WM502
2-1/2" x 3/4"

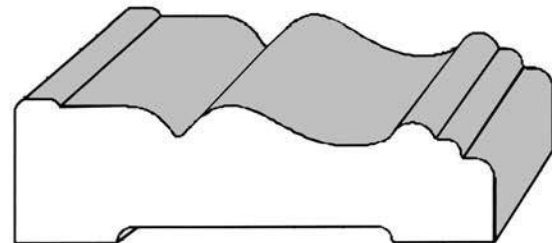

WM506
2-1/2" x 3/4"

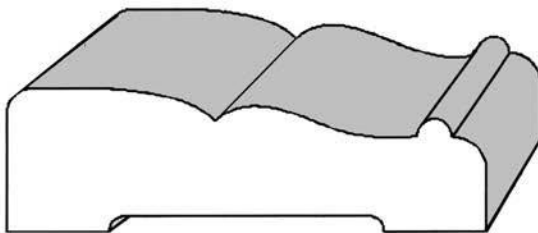

WM503
2-1/2" x 3/4"

COLONIAL CASING - Molding Patterns

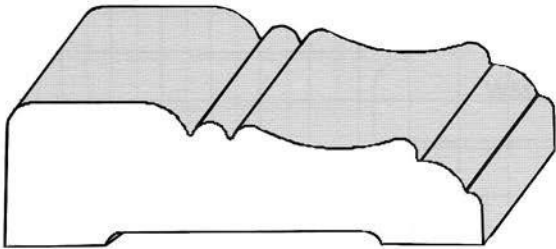

WM507
2-1/2" x 3/4"

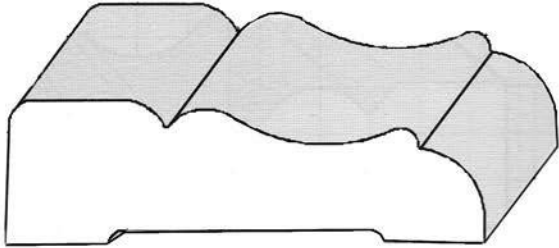

WM510
2-1/2" x 3/4"

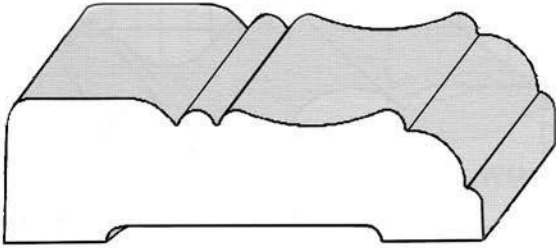

WM508
2-1/2" x 3/4"

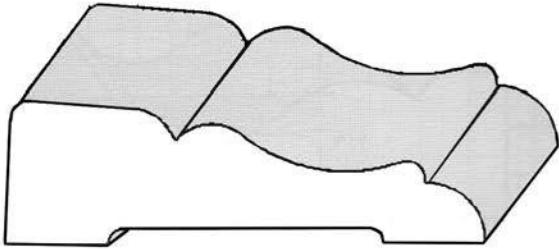

WM511
2-1/2" x 3/4"

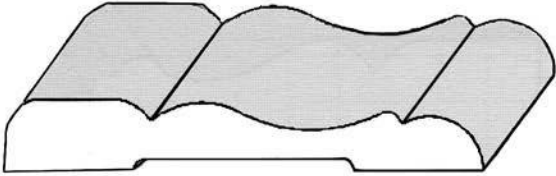

WM509
2-1/2" x 3/8"

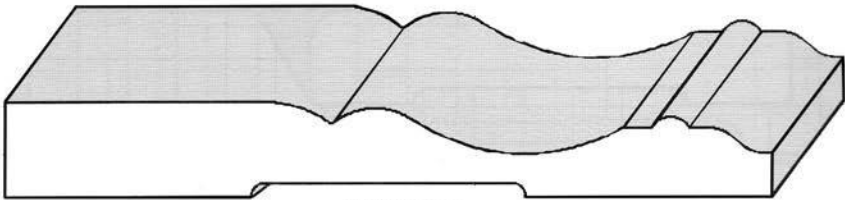

WM512
4" x 1/2"

BASE-Molding Patterns

Base molding is applied where walls and floors meet, forming a pleasing visual foundation for the room. It protects the walls from damage from furniture and vacuum cleaners and neatly hides uneven junctions of floor and wall.

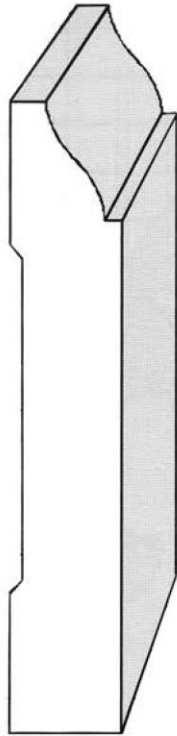

- WM618** 9/16" X 5-1/4"
- WM620** 9/16" X 4-1/4"
- WM622** 9/16" X 3-1/2"
- WM623** 9/16" X 3-1/4" (Illus.)
- WM624** 9/16" X 3"

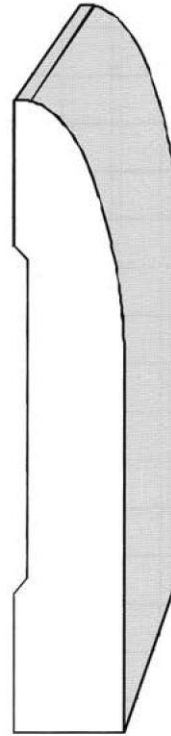

- WM709** 9/16" X 4-1/2"
- WM710** 9/16" X 4-1/4"
- WM712** 9/16" X 3-1/2"
- WM713** 9/16" X 3-1/4" (Illu)
- WM714** 9/16" X 3"

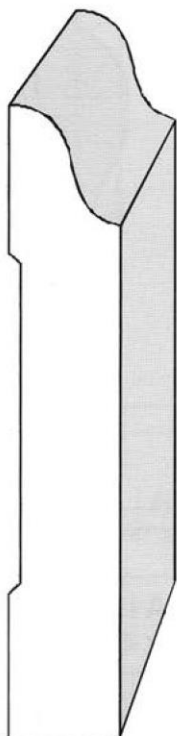

- WM658** 9/16" X 5-1/4"
- WM660** 9/16" X 4-1/4"
- WM662** 9/16" X 3-1/2"
- WM663** 9/16" X 3-1/4" (Illus.)
- WM664** 9/16" X 3"

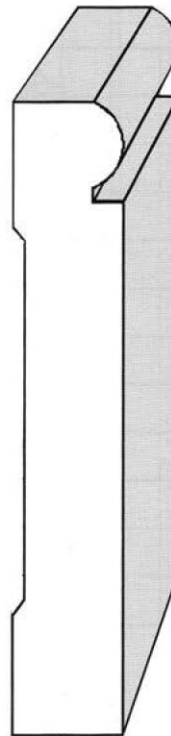

- WM750** 9/16" X 4-1/4"
- WM752** 9/16" X 3-1/2"
- WM753** 9/16" X 3-1/4" (Illu)

BASE - Molding Patterns

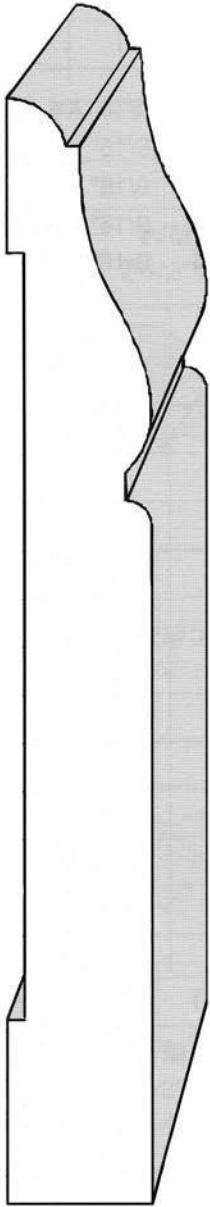

A11
3/4" X 5-3/4"

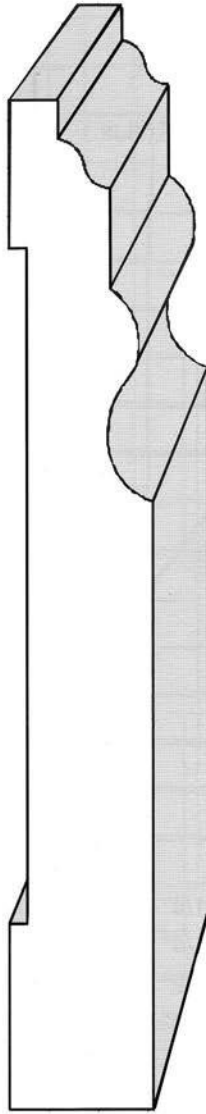

A12
3/4" X 5-1/4"

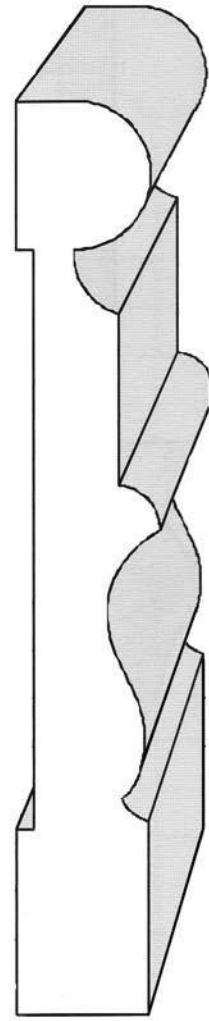

A13
3/4" X 4-3/4"

BASE- Molding Patterns

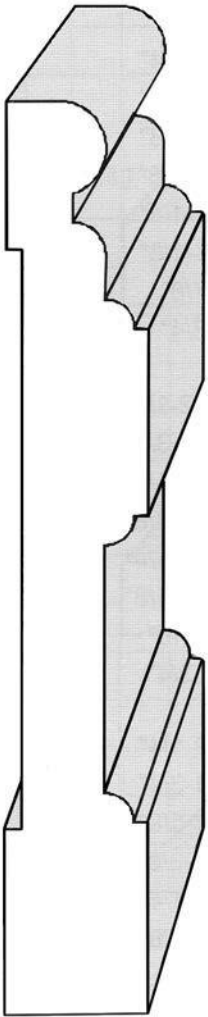

A14
3/4" X 4-3/4"

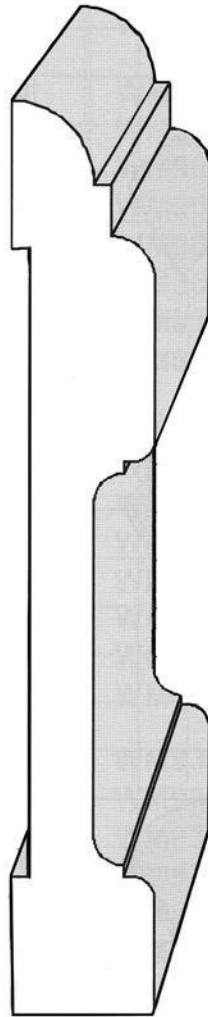

A15
3/4" X 4-3/4"

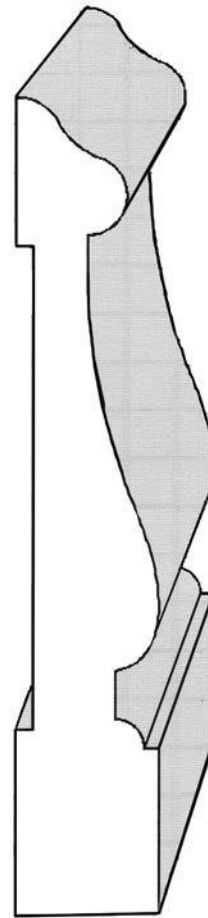

A16
3/4" X 4-1/4"

STOP - Molding Patterns

Stop molding is used in trimming windows and doors and is nailed to the face of the frame. It keeps a window sash in place and prevents a door from swinging through.

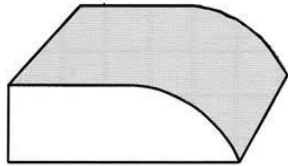

- WM813** 7/16" X 2-1/4"
- WM814** 7/16" X 1-3/4"
- WM815** 7/16" X 1-5/8"
- WM816** 7/16" X 1-3/8" (Illus.)
- WM817** 7/16" X 1-1/4"
- WM818** 7/16" X 1-1/8"
- WM820** 7/16" X 7/8"

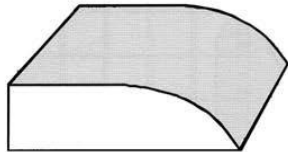

- WM823** 3/8" X 2-1/4"
- WM824** 3/8" X 1-3/4"
- WM825** 3/8" X 1-5/8"
- WM826** 3/8" X 1-3/8" (Illus.)
- WM827** 3/8" X 1-1/4"
- WM828** 3/8" X 1-1/8"
- WM830** 3/8" X 7/8"
- WM831** 3/8" X 3/4"

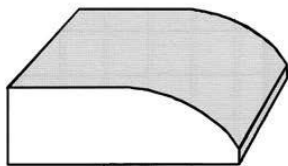

- WM843** 7/16" X 2-1/4"
- WM844** 7/16" X 1-3/4"
- WM845** 7/16" X 1-5/8"
- WM846** 7/16" X 1-3/8" (Illus.)
- WM847** 7/16" X 1-1/4"
- WM848** 7/16" X 1-1/8"
- WM850** 7/16" X 7/8"
- WM851** 7/16" X 3/4"

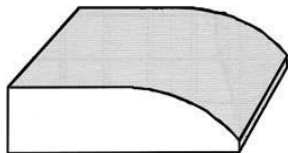

- WM853** 3/8" X 2-1/4"
- WM854** 3/8" X 1-3/4"
- WM855** 3/8" X 1-5/8"
- WM856** 3/8" X 1-3/8" (Illus.)
- WM857** 3/8" X 1-1/4"
- WM858** 3/8" X 1-1/8"
- WM860** 3/8" X 7/8"
- WM861** 3/8" X 3/4"

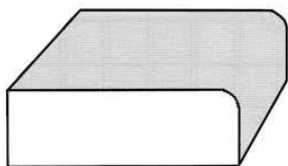

- WM873** 7/16" X 2-1/4"
- WM874** 7/16" X 1-3/4"
- WM875** 7/16" X 1-5/8"
- WM876** 7/16" X 1-3/8" (Illus.)
- WM877** 7/16" X 1-1/4"
- WM878** 7/16" X 1-1/8"
- WM880** 7/16" X 7/8"
- WM881** 7/16" X 3/4"

STOP- Molding Patterns

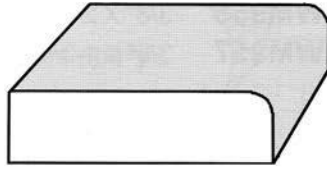

- WM883** 3/8" X 2-1/4"
- WM884** 3/8" X 1-3/4"
- WM885** 3/8" X 1-5/8"
- WM886** 3/8" X 1-3/8" (Illus.)
- WM887** 3/8" X 1-1/4"
- WM888** 3/8" X 1-1/8"
- WM890** 3/8" X 7/8"
- WM891** 3/8" X 3/4"

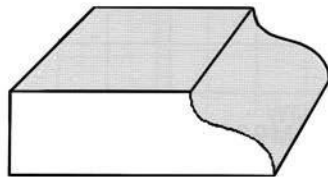

- WM903** 7/16" X 2-1/4"
- WM904** 7/16" X 1-3/4"
- WM905** 7/16" X 1-5/8"
- WM906** 7/16" X 1-3/8" (Illus.)
- WM907** 7/16" X 1-1/4"
- WM908** 7/16" X 1-1/8"
- WM910** 7/16" X 7/8"
- WM911** 7/16" X 3/4"

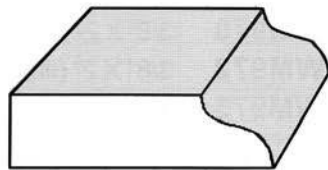

- WM913** 3/8" X 2-1/4"
- WM914** 3/8" X 1-3/4"
- WM915** 3/8" X 1-5/8"
- WM916** 3/8" X 1-3/8" (Illus.)
- WM917** 3/8" X 1-1/4"
- WM918** 3/8" X 1-1/8"
- WM920** 3/8" X 7/8"
- WM921** 3/8" X 3/4"

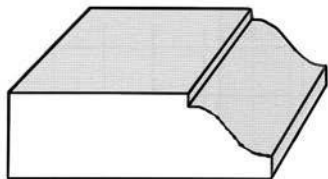

- WM933** 7/16" X 2-1/4"
- WM934** 7/16" X 1-3/4"
- WM935** 7/16" X 1-5/8"
- WM936** 7/16" X 1-3/8" (Illus.)
- WM937** 7/16" X 1-1/4"
- WM938** 7/16" X 1-1/8"
- WM940** 7/16" X 7/8"
- WM941** 7/16" X 3/4"

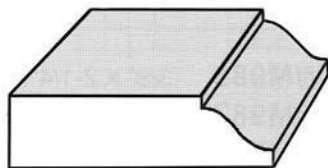

- WM943** 3/8" X 2-1/4"
- WM944** 3/8" X 1-3/4"
- WM945** 3/8" X 1-5/8"
- WM946** 3/8" X 1-3/8" (Illus.)
- WM947** 3/8" X 1-1/4"
- WM948** 3/8" X 1-1/8"
- WM950** 3/8" X 7/8"
- WM951** 3/8" X 3/4"

PANEL STRIP / MULLION CASING- Patterns

These shapes are commonly used to cover and hide the seam where two or more pieces of paneling join, or simply as wall surface decoration. As mullions, they have been applied over the window jambs in a multiple-opening window.

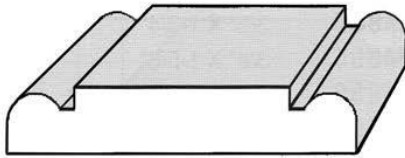

WM955 3/8" X 2-1/4"
WM956 3/8" X 2" (Illus.)
WM957 3/8" X 1-3/4"

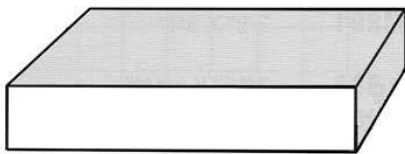

WM960 3/8" X 2-1/4"
WM962 3/8" X 2" (Illus.)
WM963 3/8" X 1-3/4"

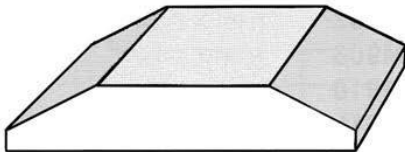

WM965 3/8" X 2-1/4"
WM967 3/8" X 2" (Illus.)
WM968 3/8" X 1-3/4"

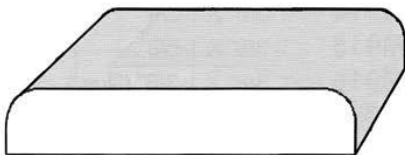

WM970 3/8" X 2-1/4"
WM972 3/8" X 2" (Illus.)
WM973 3/8" X 1-3/4"

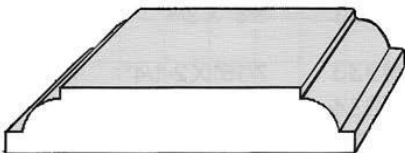

WM975 3/8" X 2-1/4"
WM977 3/8" X 2" (Illus.)
WM978 3/8" X 1-3/4"

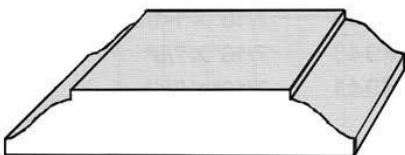

WM980 3/8" X 2-1/4"
WM982 3/8" X 2" (Illus.)
WM983 3/8" X 1-3/4"

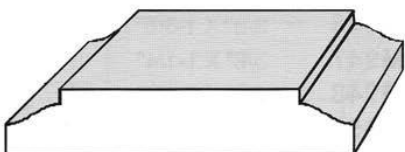

WM985 3/8" X 2-1/4"
WM987 3/8" X 2" (Illus.)
WM988 3/8" X 1-3/4"

Molding Patterns - BULLNOSE

Bullnose is similar to 1/2 round which would be 1/2 of a circle. Common places you would use bullnose would be on stair tread returns.

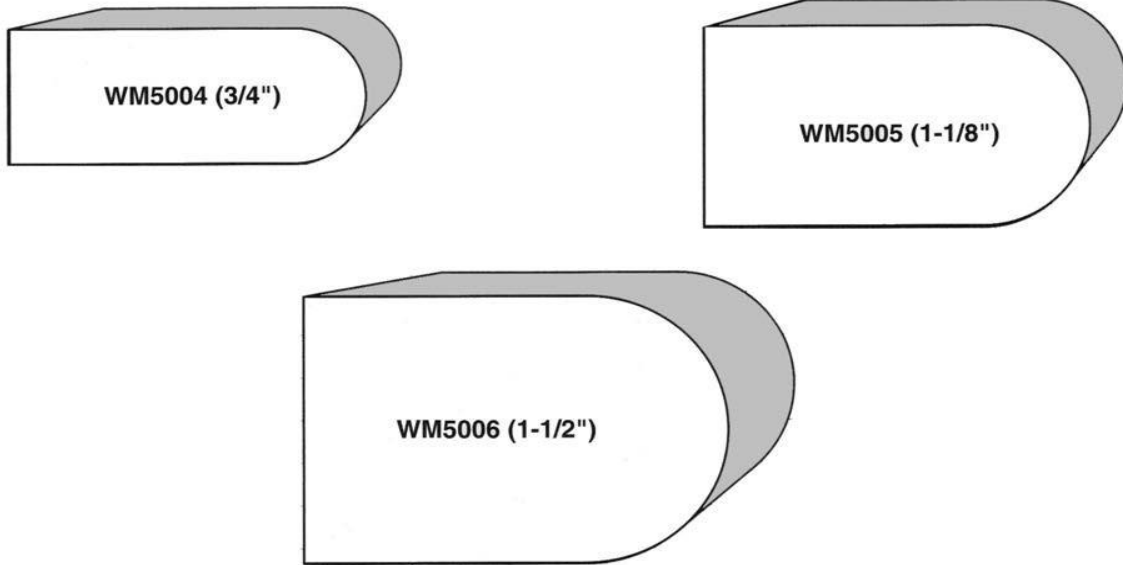

BRICK - Molding Patterns

Brick molding is a strip of material used to close the small gap between a brick wall and the frame of a door or window set into the wall. Hardwood was the traditional material used for brick molding. Because hardwoods are resistant to rot and moisture damage, hardwood brick molding has a long service life, sometimes as long as 50 years. Today, brick molding is often made of softwood with a life of only 15 years.

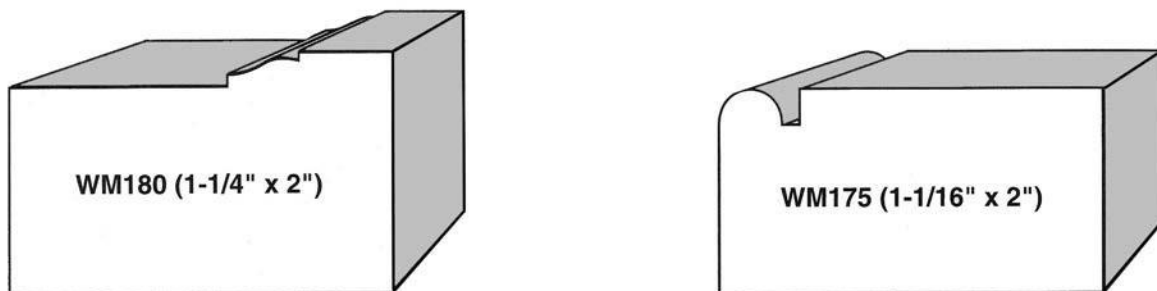

Molding Patterns - PLINTH

Plinth molding patterns are most often used in combination with matching, square, plinth blocks surrounding a door or window.

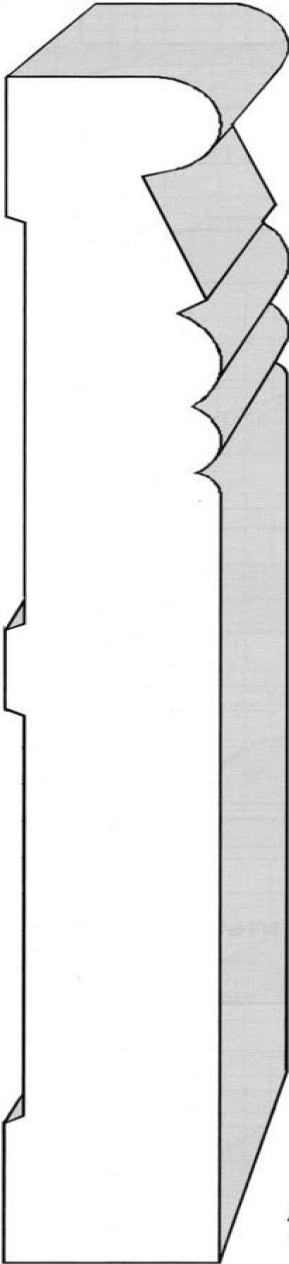

A48A
1" X 8"

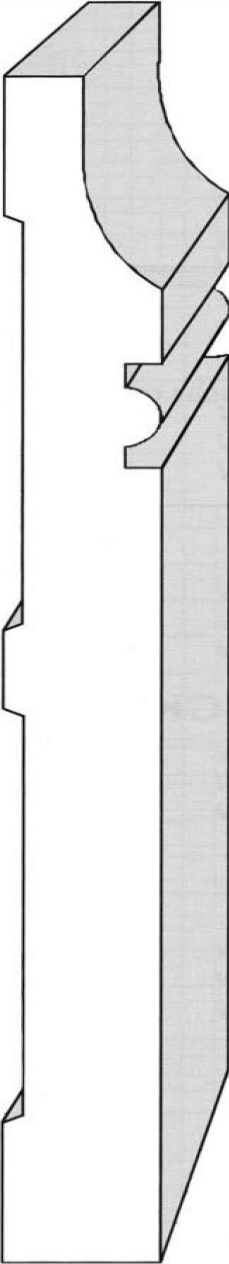

A49A
3/4" X 8"

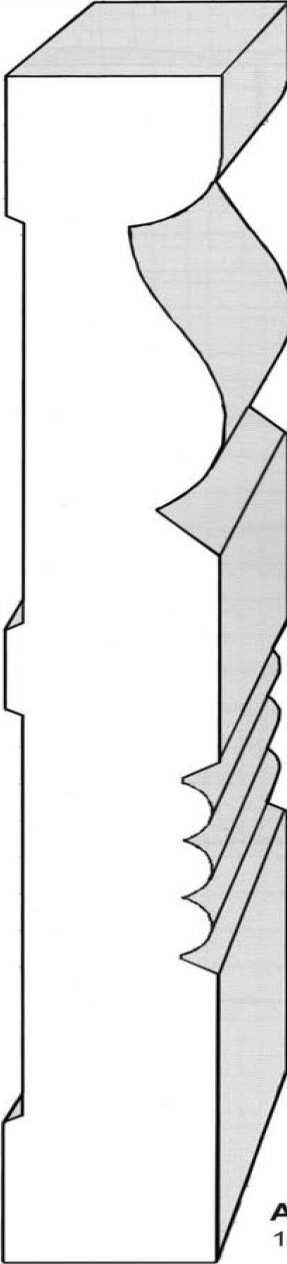

A50A
1" X 8"

WOOD PLANK PANELING - Patterns

Wood Plank Paneling is a handsome way to add a finishing touch to any room. Shiplap' design makes installation relatively simple.

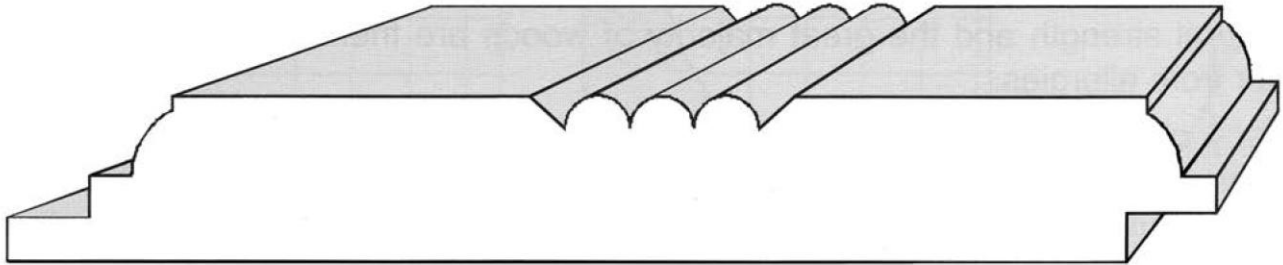

PS81
5-1/2" X 3/4"

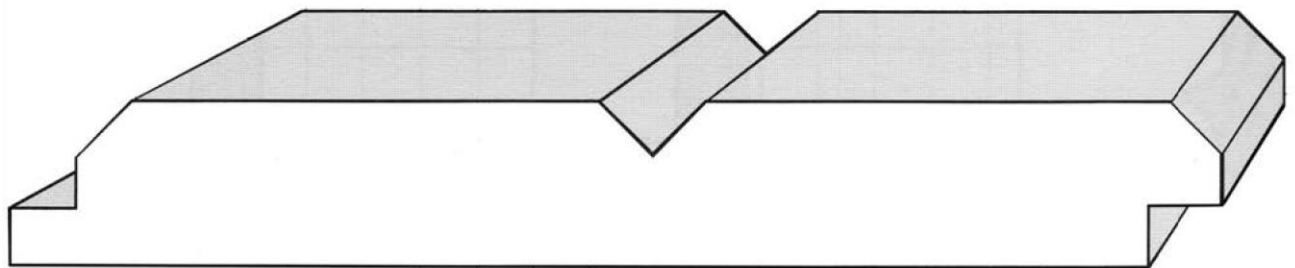
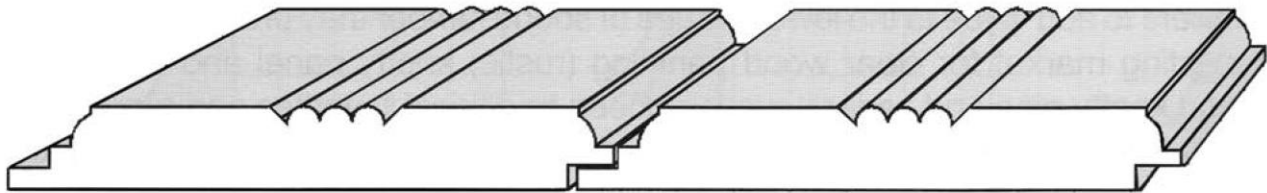

PS83
5-1/2" X 3/4"

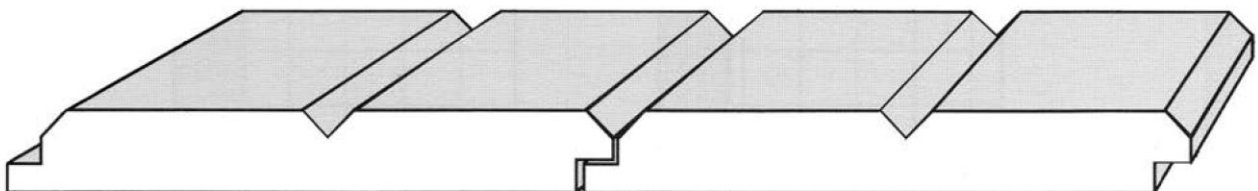

Patterns - WOOD PLANK PANELING

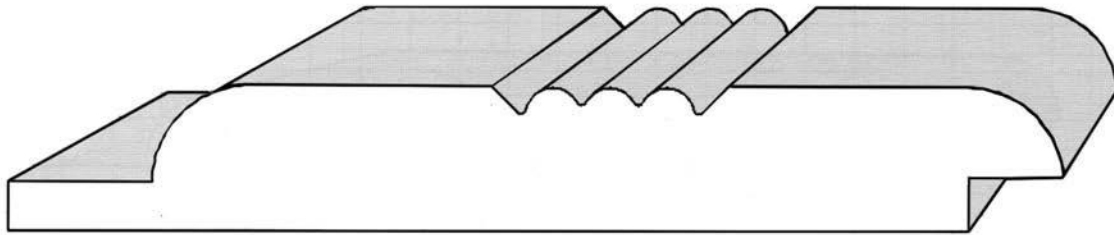

PS84
5-1/2" X 3/4"

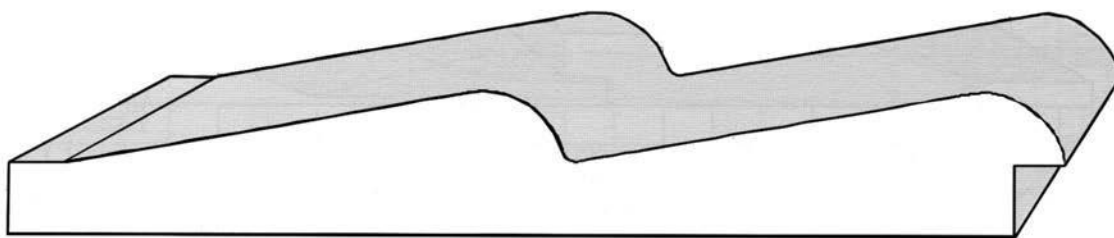
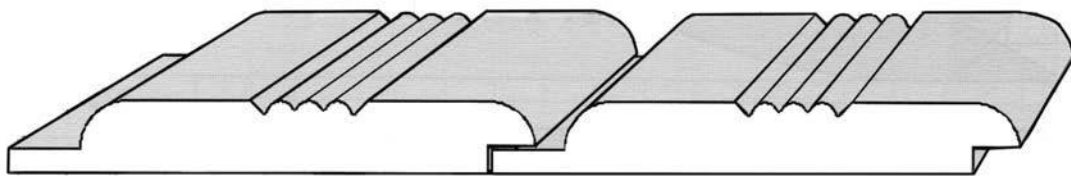

PS85
5-1/2" X 3/4"

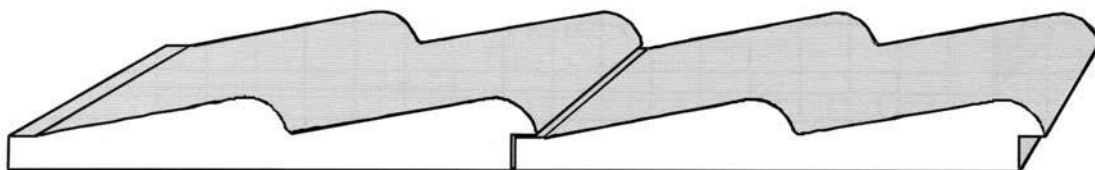

WOOD PLANK PANELING - Patterns

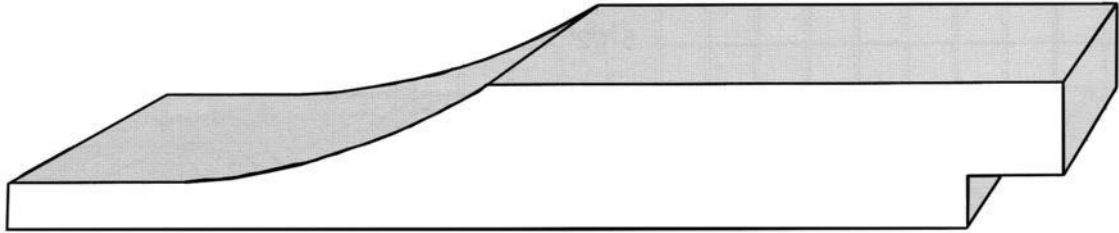

PS86
5-1/2" X 3/4"

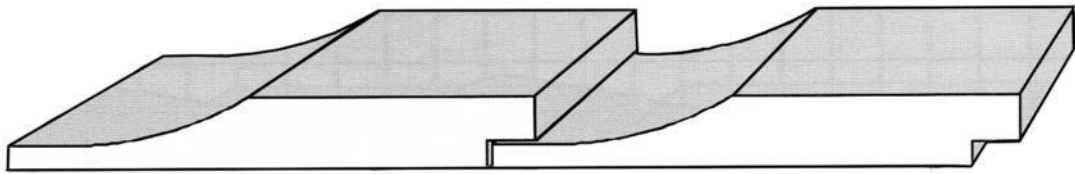

WOOD PLANK PANELING

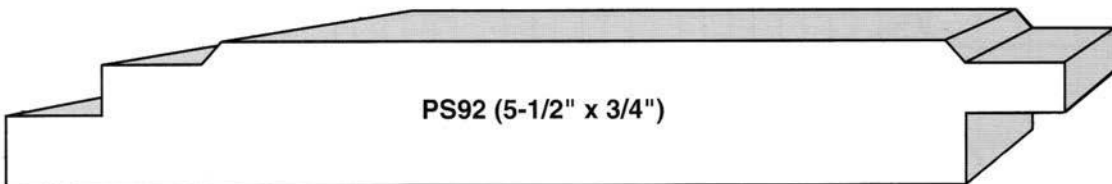
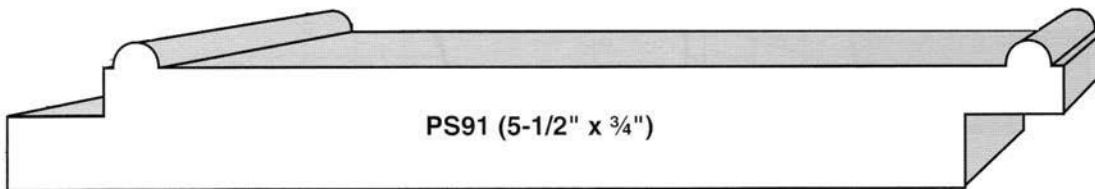
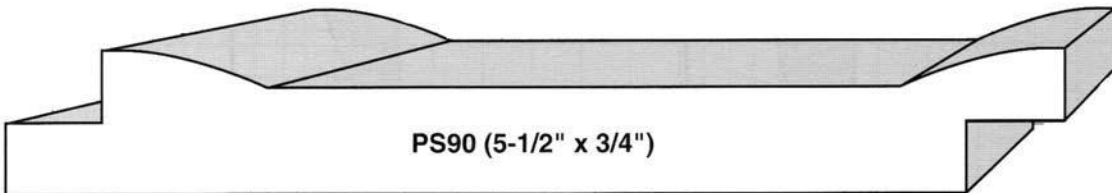
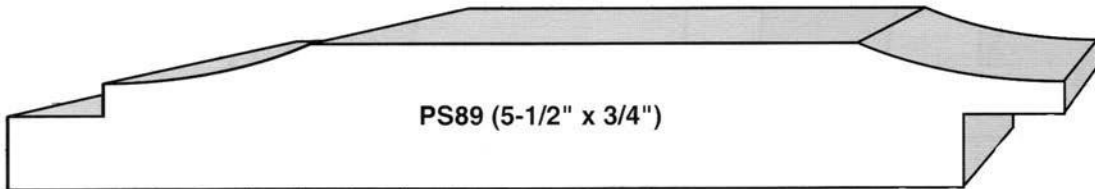
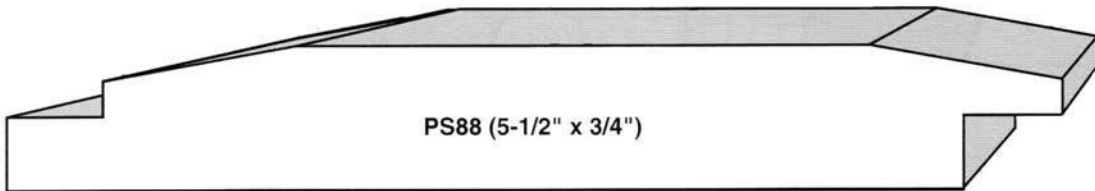
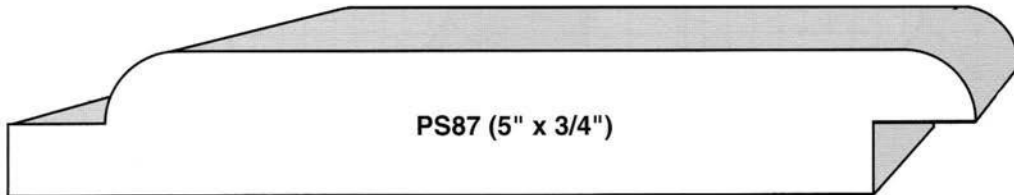
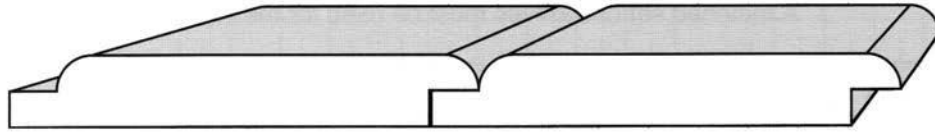

LOG CABIN SIDING - Patterns

This siding has a rounded outside surface for "looks" and a flat inside surface for easy installation. Ship-lap design avoids gaps and sheds moisture.

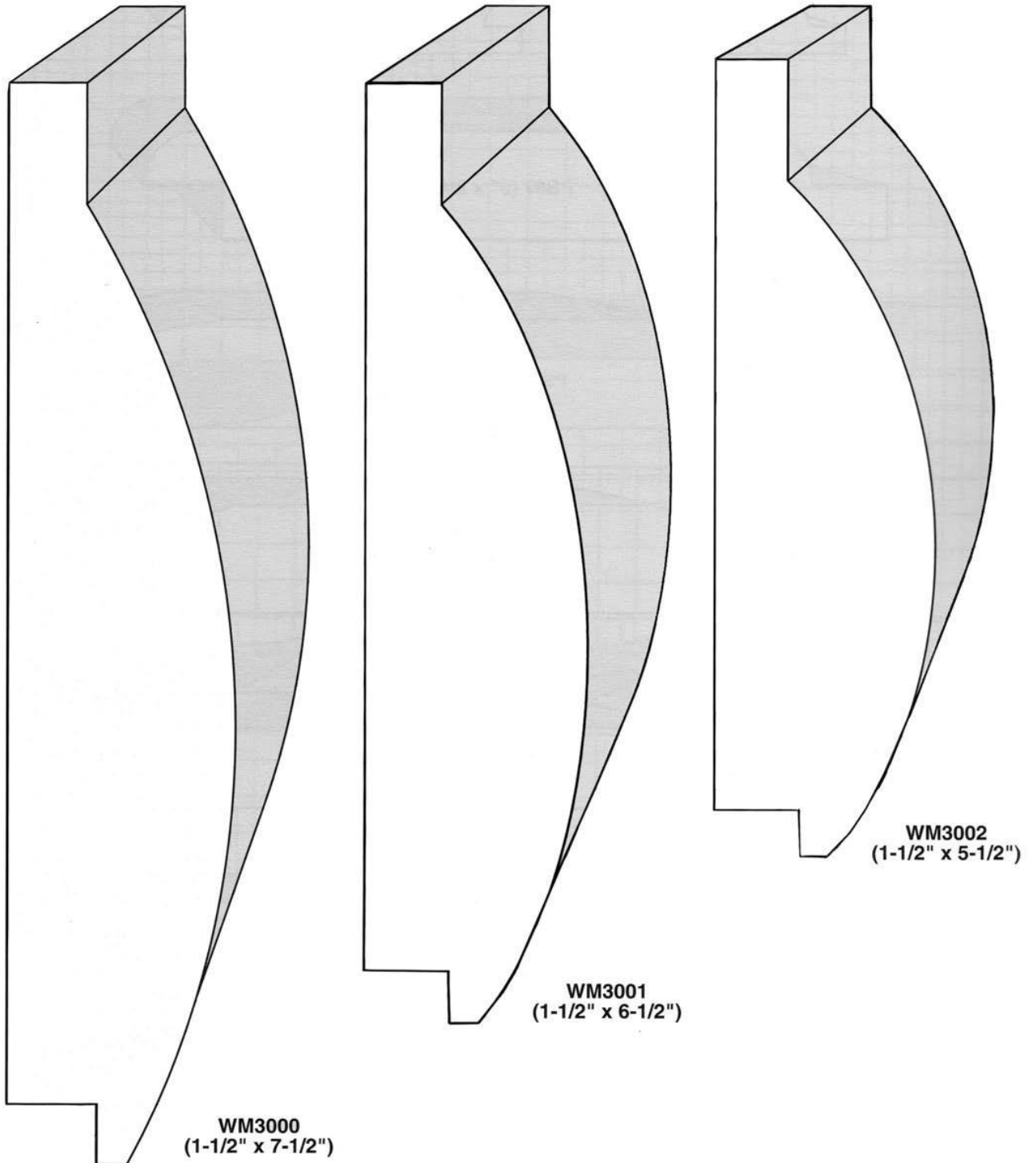

LOG CABIN SIDING- Patterns

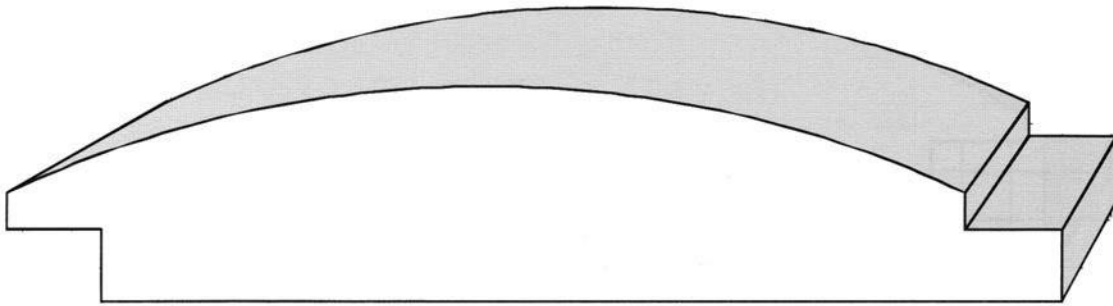

WM3010 WRAP-AROUND

1-1/8" X 5-1/2"

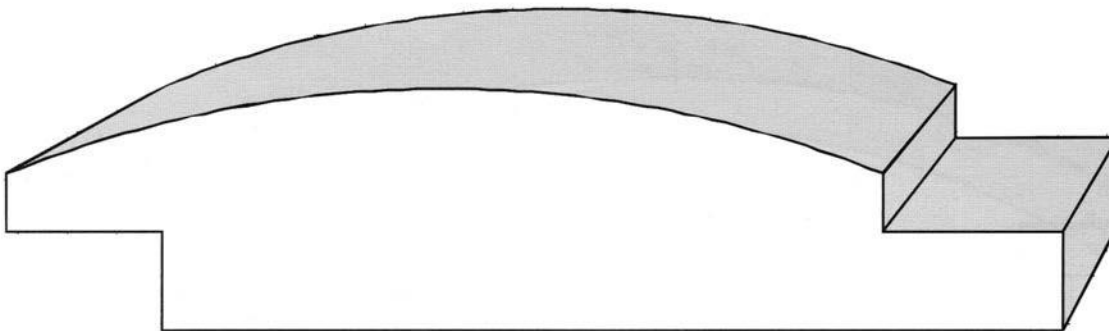

WM3011

1-1/4" X 5-1/2"

LOG CABIN SIDING - Patterns

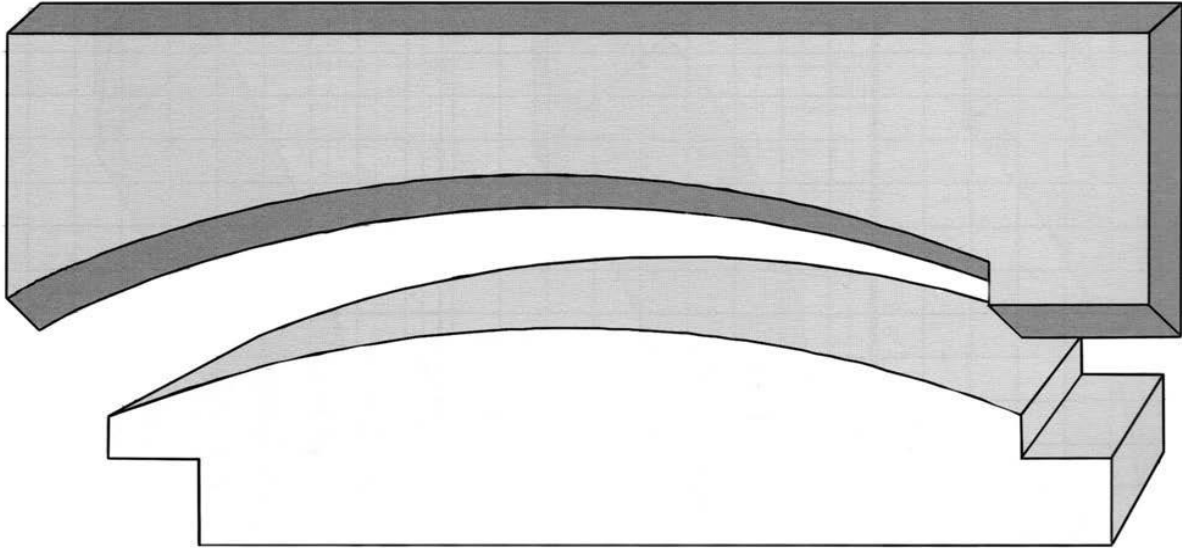

WM3012 OPEN-ENDED
1-1/4" X 5-1/2"

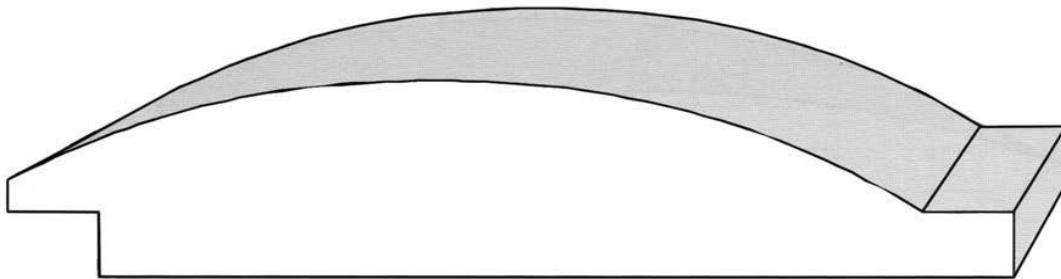

WM3013
1-1/8" X 5-1/2"

Patterns - LOG CABIN SIDING

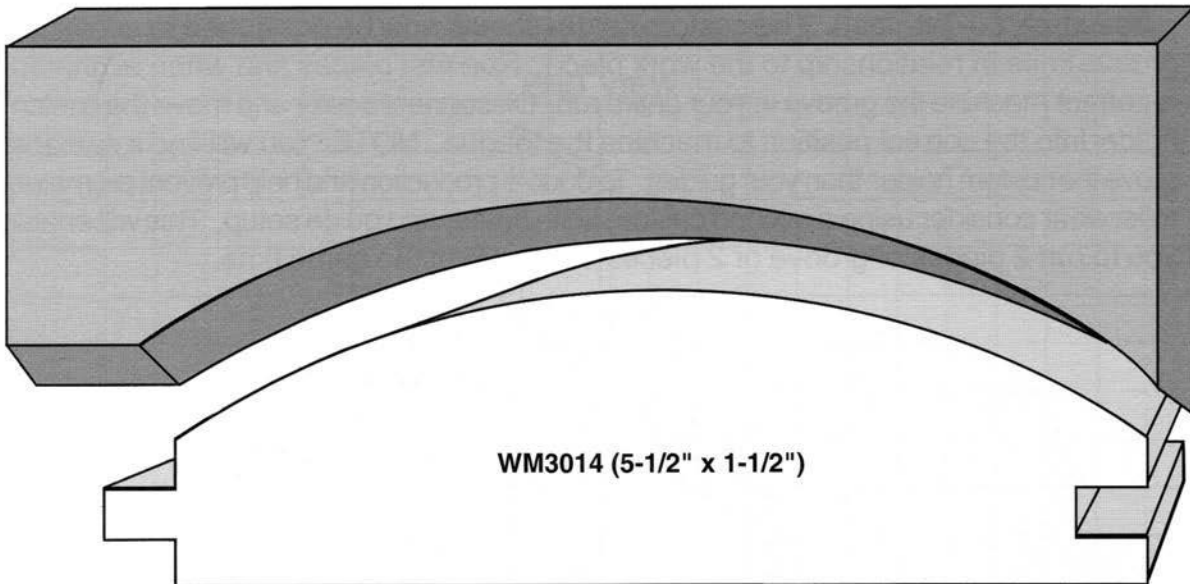
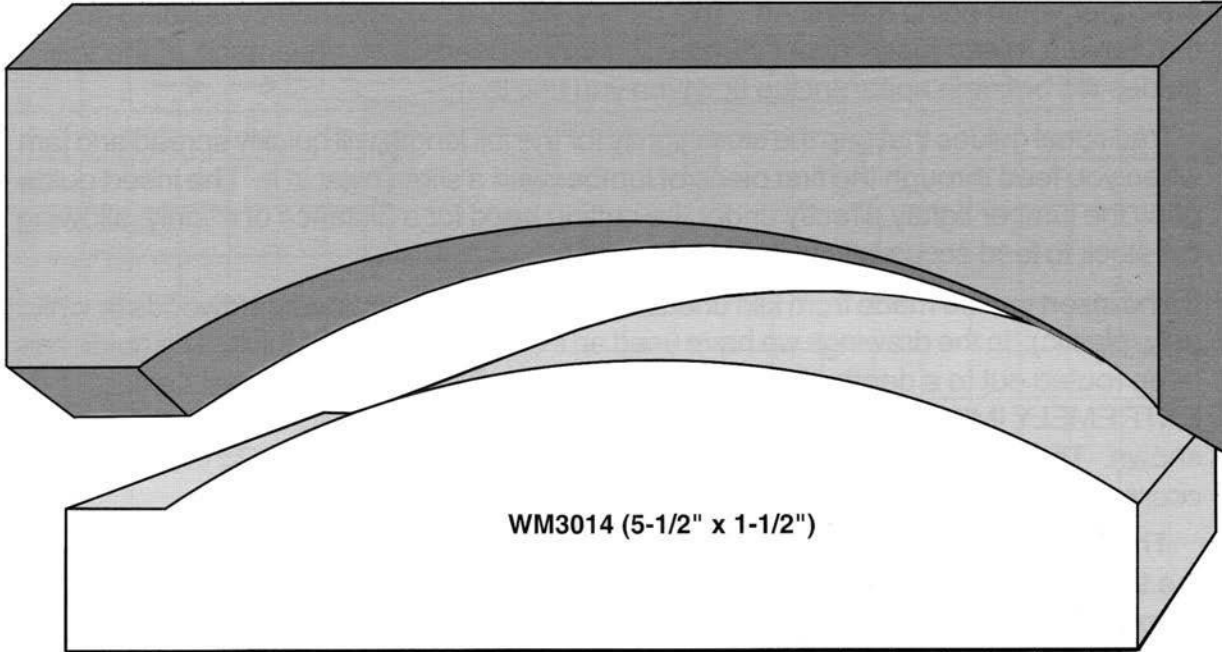

TONGUE & GROOVE - Patterns

Boards have been edged with a tongue & groove pattern for centuries. It's a strong and simple way to join wood for flooring, paneling, tabletops, etc.

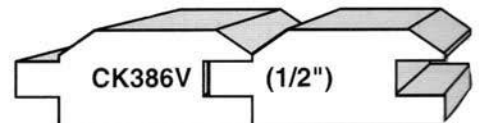
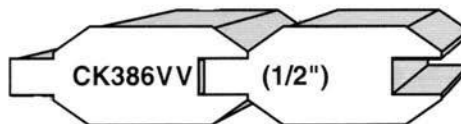
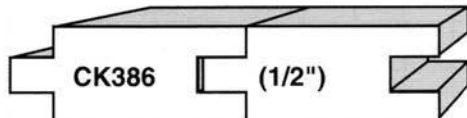
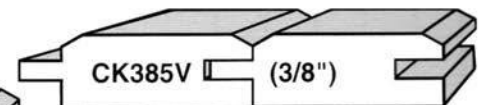
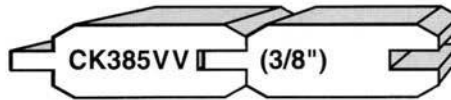
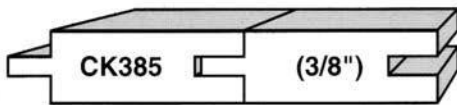
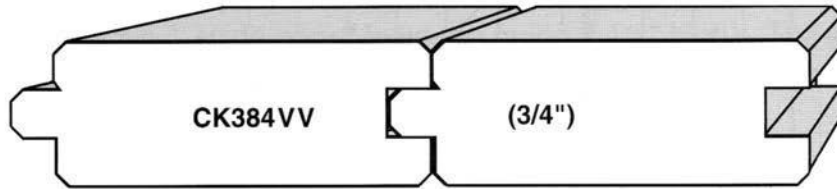
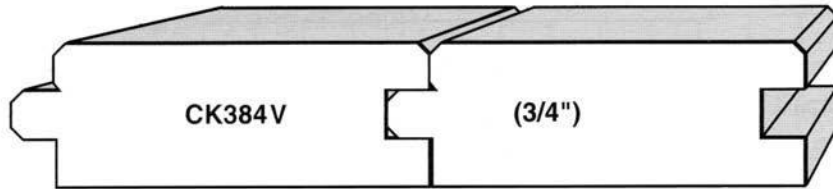
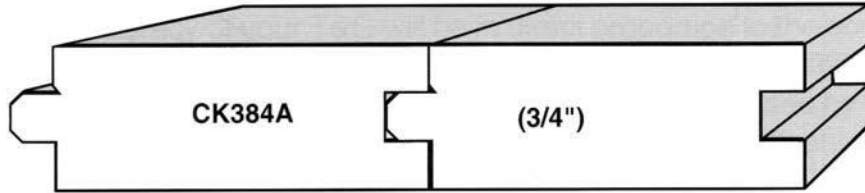

Patterns - TONGUE & GROOVE

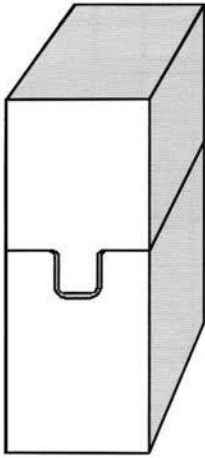

CK388
1"

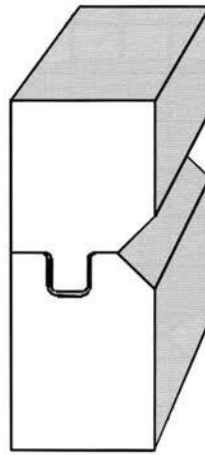

CK388V
1"

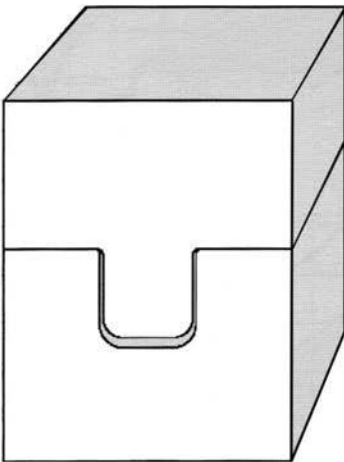

CK389
2"

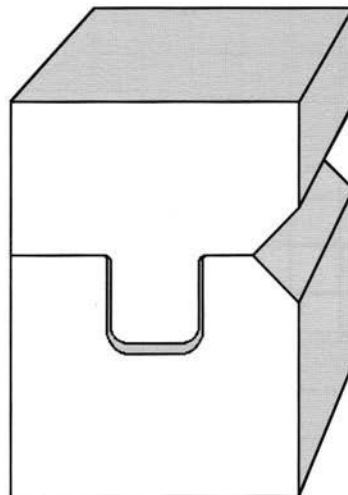

CK389V
2"

BAR RAIL - Patterns

